

管工機材

# Moritec 商品一覧



株式会社 モリテック

vol.04

# INDEX

## 排水金具

目皿 P.1



掃除口 P.2

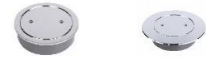

防虫目皿 P.3~P.4



ワンタッチ  
開閉掃除口 P.5



洗濯排水口 P.5



砲金継手 P.6



クローム継手 P.7



ユニット継手(1) P.8



ユニット継手(2) P.9



巻フレキ・関連部品 P.10



関連部品 P.11



ブレードホース P.12



追炊きホース P.13



























































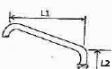

















循環アダプター P.13



# INDEX

追炊きホース 関連部材	P.14					
排水プレート	P.15					
排水ザガネ	P.16					
サドルバンド	P.17					
水栓金具	P.18					
ステンレス水栓柱	P.18					
ガーデンパン	P.18					
配管部材	P.19					
取付ビスA・Y	P.20					
便器用フランジ	P.20					
ステンレスフレキ	P.21~P.23					
ステンレス フレキ金具	P.23					
S・Pトラップ関連部品	P.24					
トラップ関連部品	P.25					
トラップ関連部品	P.26					

# INDEX

アンクルヘリューズ P.27							
小便ヘリューズ P.28							
ロータンクL管・P管 P.29							
トラップシールワン P.30							
アンクルニップル 1/2 ・ 3/4 P.31~P.33							
FV給水ニップル P.33~P.34							
洗浄バンド管 P.35							
差込バンド管 P.36							
差込継手 P.37							
アダプター P.38							
支持金具 P.39							
水栓自在吐水口 P.40							
サニタリー P.41							
手すり取付ビス P.42							
パック							
配管継手 P.43							
パック							
水栓部品 P.44							
							

# INDEX

パック

トラップ部品 P.45



パック

シールワン P.46



パック

接続部材 P.47



レベルバンド P.48



兼用レベルバンド P.49



蝶番式吊・立バンド P.50



組式G・VP立バンド P.51



組式G・VP吊バンド P.52



吊・立バンド ドブ P.53



Uボルト P.54



SU管用デップバンド P.54



ユニクロ・ステンレス  
Uバンド P.55



ユニクロ・ステンレス  
アングル P.56~P.57



フラットバー P.56



40S・40Wブラケット P.58~P.59



50S・50Wブラケット P.60~P.61



ベースチャンネル P.62~P.63



ベースチャンネル  
ロング P.63



アングル接続金具 P.64



# INDEX

門型ブラケット P.65

スーパーブラケット  
(三角) P.65

ツバ付足 P.66

プレス・溶接T字足 P.67

ボルト・ナット P.68～P.69

芯棒打込式アンカー P.70

ウエッジ式アンカー P.71

ステンレス製  
散水栓ボックス P.72～P.73



## ご注意とお願い

表示価格には消費税相当額は含まれておりません。別途消費税相当額のご負担をお願い致します。特別な取り決めのない場合、原則として下記の基本条件にてお取引下さいますようお願い申し上げます。

### 仕様について

当価格表に掲載の商品は、諸般の事情により予告なしに、仕様の変更、価格の改訂等を行う場合がございますので予めご了承下さい。

### 発注方法について

発注はFAXにて正式受注とさせていただきます。

### 運賃について

運賃は別途請求させていただきます。

### 販売単位、及び数量について

お買い上げは販売単位数でお願い致します。販売単位数以外でのお買い上げにつきましては、別途、卸売価格を設定させていただきます。

### 返品について

万一不良品がありましたときには、お取替え致します。良品での返品は、一切お断り致します。従って十分にお確かめの上発注頂きますようお願い致します。

■排水金物 目皿関係





	品番	品名	サイズ	ケース入数	販売単位	標準価格	
	M121V	WS兼用目皿	40	100	10	¥1,500	
			50	100	10	¥1,710	
			65	100	10	¥2,300	
			75	100	10	¥2,810	
			100	60	10	¥3,800	
			125	10	1	¥10,300	
			150	10	1	¥13,000	
	M121P	VP目皿	25	10	10	¥1,530	
			30	10	10	¥1,530	
			200	1	1	¥43,200	
	M126	WS兼用フローリング目皿	40	10	10	¥2,760	
			50	10	10	¥3,240	
			65	10	10	¥4,200	
			75	10	10	¥4,860	
			100	10	10	¥6,940	
			125	5	1	¥17,000	
			150	5	1	¥26,000	
	M124	兼用トラップ付目皿	50	20	20	¥3,600	
	M125	兼用トラップ付ツバ広目皿	50	20	20	¥3,850	

■排水金物 掃除口関係

	品番	品名	サイズ	ケース入数	販売単位	標準価格	
	M161V	WS兼用掃除口	40	100	10	¥1,580	
			50	100	10	¥1,800	
			65	100	10	¥2,420	
			75	100	10	¥3,100	
			100	60	10	¥4,200	
			125	10	1	¥11,100	
			150	10	1	¥14,600	
	M161P	VP用掃除口	25	10	10	¥1,660	
			30	10	10	¥1,660	
			200	1	1	¥45,100	
	M164V	WS兼用フローリング掃除口	40	100	10	¥2,340	
			50	100	10	¥2,760	
			65	100	10	¥3,700	
			75	60	10	¥4,300	
			100	10	10	¥6,100	
			125	10	1	¥17,900	
			150	10	1	¥27,000	
	M164P	VP用フローリング掃除口	30	10	10	¥2,880	
			200	1	1	¥65,800	



■排水金物 防虫目皿関係

	品番	品名	サイズ	ケース入数	販売単位	標準価格
	M152V	WS兼用防虫目皿	40	100	10	¥2,610
			50	100	10	¥2,790
			65	100	10	¥3,960
			75	100	10	¥4,680
			100	60	10	¥5,620
			125	10	1	¥13,500
			150	10	1	¥21,600
	M151V	WSVC兼用防虫目皿(一体型)	40	10	10	¥2,030
			50	10	10	¥2,480
			65	10	10	¥3,190
			75	10	10	¥3,800
			100	10	10	¥4,950
			125	1	1	¥11,000
			150	1	1	¥16,000
	M152P	VP防虫目皿	20	10	10	¥2,220
			25	10	10	¥2,220
			30	10	10	¥2,220
			200	1	1	¥52,200
	M153A	内ネジ防虫目皿	20	10	10	¥2,930
			25	10	10	¥2,930
			30	10	10	¥2,930
			40	10	10	¥3,120
			50	10	10	¥3,480
	M159	山型防虫目皿	40	10	10	¥9,100
			50	10	10	¥9,890
			65	10	10	¥14,700
			75	10	10	¥16,500
			100	10	10	¥20,700

■排水金物 防虫関係

	品番	品名	サイズ	ケース入数	販売単位	標準価格	
	M156	WS兼用フローリング防虫目皿	40	10	10	¥3,170	
			50	10	10	¥3,420	
			65	10	10	¥4,650	
			75	10	10	¥5,700	
			100	10	10	¥7,270	
	M157	WSアレスター	40	10	10	¥4,290	
			50	10	10	¥4,730	
			65	10	10	¥7,040	
			75	10	10	¥8,630	
			100	10	10	¥11,100	
	M158	WSツバ広アレスター	40	10	10	¥4,350	
			50	10	10	¥5,800	
			65	10	10	¥8,300	
			75	10	10	¥9,060	
			100	10	10	¥12,000	
	M155	樹脂製防虫目皿	40	100	10	¥1,050	
			50	100	10	¥1,150	
	M154A	外ネジ防虫目皿	20	10	10	¥2,280	
			25	10	10	¥2,280	
			30	10	10	¥2,280	
	M154		40	10	10	¥2,360	
			50	10	10	¥2,690	
			65	10	10	¥3,490	
			75	10	10	¥4,300	
			100	10	10	¥5,400	

■排水金物 掃除口関係・洗濯機排水

	品番	品名	サイズ	ケース入数	販売単位	標準価格	
	M167	兼用ストレーナー付掃除口	50	100	10	¥3,300	
			65	100	10	¥5,600	
			75	100	10	¥5,900	
			100	60	10	¥7,700	
	M168	兼用ストレーナー付ツバ広掃除口	50	100	10	¥4,400	
			65	100	10	¥7,000	
			75	60	10	¥7,300	
			100	10	10	¥10,500	
	M171	兼用ドライバー開封掃除口	40	100	10	¥1,520	
			50	100	10	¥2,100	
			65	100	10	¥2,900	
			75	100	10	¥3,550	
			100	60	10	¥5,090	
	M172	兼用ドライバー開封ツバ広掃除口	50	100	10	¥2,730	
			65	100	10	¥3,780	
			75	60	10	¥4,300	
			100	10	10	¥6,090	
	M143	兼用防臭式洗濯排水口	50	100	10	¥3,100	
	M143T	ツバ広兼用防臭式洗濯機排水口	50	100	10	¥3,840	
	M144	兼用洗濯排水口(L型)	50	10	10	¥3,210	
	M144T	ツバ広兼用洗濯排水口(L型)	50	10	10	¥3,800	
	M146	兼用洗濯機排水トラップ (樹脂ナット)	50	20	20	¥3,990	
	M146B	兼用洗濯機排水トラップ (真鍮ナット)	50	20	20	¥4,400	

■砲金継手

						
品番	M420	M420A	M420B	M421	M422	M423
品名	エルボ	45° エルボ	ストリートエルボ	チーズ	六角ニップル	ソケット
15A	¥1,270	¥1,400	¥1,500	¥1,680	¥950	¥1,120
20A	¥1,650	¥2,500	¥2,250	¥2,140	¥1,470	¥1,600
25A	¥3,000		¥3,300	¥3,960	¥2,200	¥2,280
32A	¥4,430			¥5,500	¥2,510	¥3,450
40A	¥5,700			¥6,980	¥3,320	¥4,000
50A	¥8,200			¥10,200	¥4,520	¥5,400
15A × 20A	¥1,600			¥2,280	¥1,500	¥1,390
15A × 25A	¥2,560			¥3,560		¥2,700
20A × 25A	¥3,100			¥3,720		¥2,700

\*小箱ケース入数は10個です。

						
品番	M424	M425	M426	M426C	M428	M429
品名	丸ニップル	ブッシング	プラグ	六角穴プラグ	ユニオン	キャップ
15A	¥840		¥780	¥900	¥3,250	¥880
20A	¥950		¥960	¥1,360	¥4,430	¥1,250
25A			¥1,330		¥6,500	¥1,760
32A						
40A						
50A						
1/2 × 1/4		¥810				
1/2 × 3/8		¥860				
3/4 × 1/2		¥1,030				
1" × 1/2		¥1,660				
1" × 3/4		¥1,760				

\*小箱ケース入数は10個です。

■クローム継手

						
品番	M481	M481A	M481B	M482	M483	M484
品名	エルボ	45° エルボ	ストリートエルボ	チーズ	六角ニップル	ソケット
15A	¥1,550	¥1,800	¥1,840	¥1,900	¥1,170	¥1,500
20A	¥2,000	¥3,110	¥2,980	¥2,400	¥1,600	¥1,750
25A	¥4,020	¥4,600	¥4,700	¥4,650	¥2,660	¥2,980
32A						
40A						
50A						
15A × 20A	¥1,930			¥2,730	¥1,700	¥1,770
15A × 25A	¥2,800			¥4,260		
20A × 25A	¥2,800			¥4,260		

\*小箱ケース入数は10個です。

						
品番	M485	M487	M488	M489	M490	M490B
品名	丸ニップル	プッシング	プラグ	ユニオン	キャップ	キャップBS
15A	¥430		¥920	¥4,850	¥1,320	¥690
20A	¥740		¥1,240	¥6,500	¥1,550	¥1,300
25A	¥1,830		¥1,600	¥9,300	¥2,080	
32A						
40A						
50A						
1/2 × 1/4		¥920				
1/2 × 3/8		¥990				
3/4 × 1/2		¥1,320				
1" × 1/2		¥1,980				
1" × 3/4		¥1,980				

\*小箱ケース入数は10個です。

■継手ユニット関係

	品番	品名	サイズ	ケース入数	販売単位	標準価格	
	M451	ユニットツギタシ(φ50)	1/2	50	10	¥1,470	
	M451D	ユニットツギタシ(ツバ広型) (φ58)	1/2	30	10	¥1,990	
	M451E	内ネジユニットツギタシ	1/2	30	10	¥2,080	
	M451ED	内ネジユニットツギタシ(ツバ広型) (φ58)	1/2	30	10	¥2,460	
	M452	パネル継手	1/2	10	10	¥2,210	
	M454	パネルショートエルボ(内ネジ)	1/2	10	10	¥3,040	
	M454G	パネルショートエルボ(外ネジ)	1/2	10	10	¥3,040	
	M458S	給湯器ニップル(オスメスアダプター)	3/4×1/2	300	50	¥720	
	M467	平面給水化粧プラグ	1/2	300	30	¥1,120	
	M462	予備給水栓プラグ	1/2	100	10	¥890	
			3/4	100	10	¥930	
			1"	10	10	¥1,850	
	M490B	クロームキャップ パッキン付 (BS)	1/2	50	10	¥690	
			3/4	10	10	¥1,280	

■接続継手

	品番	品名	サイズ	ケース入数	販売単位	標準価格	
	M459	接続ユニオン	1/2×1/2	10	10	¥1,230	
			3/4×3/4	10	10	¥1,650	
			3/4×1/2	10	10	¥2,120	
	M460	両ナットユニオン	1/2×1/2	10	10	¥1,200	
			3/4×3/4	10	10	¥1,650	
	M640	分岐金具(片ナット付)ミガキ	1/2	120	10	¥2,340	
	M641	逆分岐金具	3/4×1/2	10	10	¥3,260	
	M642	分岐金具(ナット付エルボ)バフなし	1/2	100	10	¥1,740	
	M642C	分岐金具(ナット付エルボ)ミガキ	1/2	100	10	¥2,160	
	M643	45° ナット付エルボ	1/2	100	10	¥1,480	
	M648B	分岐金具(片ナット付)バフなし	1/2	100	10	¥1,790	
	M640B	分岐金具(二方ナット付)	1/2×1/2	10	10	¥3,160	
	PK415	内外アダプター	1/2×W24山16	10	10	¥1,300	
	PM744	内外アダプター	W26山20 ×W24山20	10	10	¥2,000	

■フレキ関連部材



	品番	品名	サイズ	ケース入数	販売単位	標準価格	
	M624	巻フレキチューブ(SUS316L)	16×10M	5	5	¥12,000	
			16.8×10M	5	5	¥12,700	
			20×10M	5	5	¥22,000	
	M627	巻フレキチューブ(SUS304)	16×10M	5	5	¥11,700	
			16.8×10M	5	5	¥12,400	
			20×10M	5	5	¥20,960	
	M628	フレキ用フクロナット	1/2×16	1000	100	¥190	
			1/2×16.8	1000	100	¥190	
			3/4×20	500	50	¥320	
	M628/S	フクロナットパッキンセット ゴム付	1/2×16	360	30	¥420	
			1/2×16.8	360	30	¥430	
			3/4×20	300	30	¥790	
	M628/A	フクロナットパッキンセット ノンアス付	1/2×16	360	30	¥430	
			1/2×16.8	360	30	¥450	
			3/4×20	300	30	¥820	
	M629/S	フレキ用ナットセット リブパッキン付	1/2×16	360	30	¥430	
			1/2×16.8	360	30	¥450	
			3/4×20	300	30	¥830	
	M634/S	ガイド付ナットセット ゴム付	1/2×16	300	30	¥800	
			1/2×16.8	300	30	¥800	
			3/4×20	300	30	¥1,360	
	M634/A	ガイド付ナットセット ノンアス付	1/2×16	300	30	¥800	
			1/2×16.8	300	30	¥800	
			3/4×20	300	30	¥1,360	
	M638/S	I型フレキ用ナットパッキンセット ゴム付	3/4×20	300	30	¥890	
	M638/A	I型フレキ用ナットパッキンセット ノンアス付	3/4×20	300	30	¥890	
	M615/S	異径フレキ用ナットパッキンセット ゴム付	3/4×1/2	120	10	¥990	
	M632	フレキ用カシメ機 Φ16/16.8/20 兼用		6	1	¥41,000	



■フレキ関連部材

	品番	品名	サイズ	ケース入数	販売単位	標準価格	
	M626	台紙付ゴムパッキン (10枚入×40袋)	1/2	2	1	¥12,000	
		台紙付ゴムパッキン (6枚入×40袋)	3/4	2	1	¥12,000	
	M626H	台紙付ノンアスパッキン (6枚入×40袋)	1/2	2	1	¥12,000	
		台紙付ノンアスパッキン (4枚入×40袋)	3/4	2	1	¥12,000	
	M633	台紙付リブ付ゴムパッキン (10枚入×40袋)	1/2	2	1	¥14,000	
		台紙付リブ付ゴムパッキン (6枚入×40袋)	3/4	2	1	¥14,400	
	M621	フレキ用ニップル	1/2	500	100	¥260	
			3/4	300	50	¥460	
			1"	200	10	¥1,330	
	M621A	A型異径ニップル	3/4×1/2	300	50	¥530	
	M621L	フレキエルボ バフなし	1/2	50	10	¥930	
			3/4	10	10	¥1,400	
			3/4×1/2	10	10	¥1,500	
	M621T	フレキチーズ バフなし	1/2	100	10	¥880	
	M494	平行ニップル	1/2	500	50	¥350	
			3/4	100	10	¥760	
	M621R	フレキニップル (ローコスト)	1/2	500	100	¥200	
			3/4	300	50	¥400	
	M621AR	A型異径フレキニップル (ローコスト)	3/4×1/2	300	30	¥450	
	M625	フレキ用ゴムパッキン	1/2	1000	100	¥30	
			3/4	1000	100	¥50	
	M625H	フレキ用ノンアスベストパッキン	1/2	1000	100	¥50	
			3/4	1000	100	¥75	
	M625R	リブ付ゴムパッキン	1/2	1000	100	¥35	
			3/4	1000	100	¥60	

■ブレードホース

	品番	品名	サイズ	ケース入数	販売単位	標準価格	
 <p>2000Lまで取り揃えて おります。 2000L～は、50<sup>リ</sup>単 位でオーダー製作可 能です。</p>	PM617	自在型ブレードホース (SUS316L 水協品)	1/2×150	10	10	¥3,190	
			1/2×200	10	10	¥3,230	
			1/2×250	10	10	¥3,320	
			1/2×300	10	10	¥3,460	
			1/2×350	10	10	¥3,500	
			1/2×400	10	10	¥3,570	
			1/2×450	10	10	¥3,690	
			1/2×500	10	10	¥3,770	
			1/2×600	10	10	¥4,010	
			1/2×700	10	10	¥4,210	
			1/2×800	10	10	¥4,390	
			1/2×900	10	10	¥4,580	
			1/2×1000	10	10	¥5,430	
			1/2×1250	1	1	¥6,080	
1/2×1500	1	1	¥6,850				
1/2×2000	1	1	¥7,670				
	M616	自在型ブレードホース (SUS316L)	3/4×200	5	5	¥8,650	
			3/4×250	5	5	¥8,980	
			3/4×300	5	5	¥9,480	
			3/4×350	5	5	¥9,800	
			3/4×400	5	5	¥10,450	
			3/4×500	5	5	¥11,090	
			3/4×600	5	5	¥12,000	
			3/4×700	5	5	¥12,640	
			3/4×1000	5	5	¥16,030	
	M620	ボールバルブ(フレキ用)	1/2	10	10	¥2,400	
			3/4	10	10	¥2,690	



■追炊きホース 関連部材

	品番	品名	サイズ	ケース入数	販売単位	標準価格	
	M670	ツインホース TPEエラストマー	13×23×20M	1	1	¥55,000	
	M690	追炊き配管ホース PVC	13×20M	1	1	¥38,000	
	M691	PVC 追炊き配管ホース	13×20M	1	1	¥36,000	
	M692	PVC 追炊き配管ホース	10A×20M	1	1	¥28,000	
	M693	S・L兼用循環アダプター	15A	10	5	¥8,000	
	M694	S・L兼用循環アダプター	10A	10	5	¥8,000	
	M699	S・L兼用循環アダプター(ネジ式)	1/2	10	5	¥8,000	
	M684	バスキャップ(内締)		10	10	¥2,000	



■追炊きホース 関連部材

	品番	品名	サイズ	ケース入数	販売単位	標準価格	
	MK031	レッドカッター		10	1	¥4,200	
	M675	ホース部品セット 4個入	13	100	10	¥3,800	
	M674	ホース部品セット(A)2個入	13	100	10	¥1,960	
	M675L	ホース部品L型セット	13	100	10	¥4,900	
	M677	ホースジョイント(S)	10A	100	10	¥2,990	
			13A	100	10	¥2,990	
	M679	ホース部品セット(G)2個入	13×1/2	100	10	¥2,420	
	M685	ポリ管用部品セット(樹脂管用)	10A	100	10	¥3,000	
	M687	ツインホース用部品セット	10A	100	10	¥3,340	
	M675B	ツインホース用バンド	10A	100	10	¥150	
			13A	100	10	¥150	
	M685B	ポリ管用バンド	10A	100	10	¥150	
	M673	ツインホース用サドルバンド	10Aツイン用	100	100	¥140	
			13Aツイン用	100	100	¥140	
	M665	ホース部品セット (ローコスト)	15A	100	10	¥3,300	
	M666	ホース部品セット (ローコスト)	10A	100	10	¥3,000	





■ビニールプレート

	品番	品名	サイズ	ケース入数	販売単位	標準価格
	M442	ビニールプレート(割) アイボリー	15A	100	10	¥210
			20A	100	10	¥230
			25A	100	10	¥250
			30A	100	10	¥320
			40A	100	10	¥360
			50A	100	10	¥480
			65A	100	10	¥580
			75A	100	10	¥770
			100A	100	10	¥870
	M442W	ビニールプレート(割) ホワイト	15A	100	10	¥210
			20A	100	10	¥230
			25A	100	10	¥250
			30A	100	10	¥320
			40A	100	10	¥360
			50A	100	10	¥480
			65A	100	10	¥580
75A			100	10	¥770	
100A			100	10	¥870	
	M443	ビニールプレート(穴無) アイボリー	50	100	10	¥200
			65	100	10	¥210
			80	100	10	¥240
			100	100	10	¥320
			120	100	10	¥370
			150	100	10	¥460
			200	100	10	¥540
	M443W	ビニールプレート(穴無) ホワイト	50	100	10	¥200
			65	100	10	¥210
			80	100	10	¥240
			100	100	10	¥320
			120	100	10	¥370
			150	100	10	¥460
			200	100	10	¥540

■給水ザガネ

	品番	品名	サイズ	ケース入数	販売単位	標準価格
	M430	給水ザガネ	1/2×3	100	100	¥85
			1/2×5	40	40	¥90
			1/2×6	40	40	¥90
			1/2×7	20	20	¥90
			1/2×8	20	20	¥95
			1/2×9	20	20	¥95
			1/2×10	20	20	¥95
			1/2×12	20	20	¥110
			1/2×13	20	20	¥110
			1/2×16	20	20	¥120
			1/2×20	20	20	¥140
			1/2×25	20	20	¥230
			1/2×30	20	20	¥750
			1/2×40	10	10	¥1,750
			1/2×50	10	10	¥2,160
			1/2×70	1	1	¥8,100
			3/4×3	100	100	¥85
			3/4×6	40	40	¥90
			3/4×10	40	40	¥100
			3/4×13	20	20	¥110
3/4×16	20	20	¥120			
3/4×20	20	20	¥150			
3/4×25	20	20	¥230			
	M440	混合栓用送りザガネ	45×15	10	1	¥1,800
			45×20	10	1	¥2,400
			45×25	10	1	¥2,800
			45×30	10	1	¥3,900
			45×35	10	1	¥4,700
			60×15	10	1	¥2,700
			60×20	10	1	¥3,400
			60×30	10	1	¥4,500
			80×10	10	1	¥5,200
			80×20	10	1	¥6,200

■サドルバンド

	品番	品名	サイズ	ケース入数	販売単位	標準価格
	M432	サドルバンド 鉄	13	200	200	¥18
			16	100	100	¥18
			20	100	100	¥22
			25	100	100	¥30
			30	100	100	¥48
			40	100	100	¥56
			50	50	50	¥75
			65	40	40	¥450
			75	30	30	¥510
			100	20	20	¥650
			125	1	1	¥950
			150	1	1	¥1,100
	M433	サドルバンド SUS	13	200	200	¥46
			16	100	100	¥50
			20	100	100	¥50
			25	100	100	¥80
			30	100	100	¥140
			40	100	100	¥160
			50	50	50	¥220
			65	40	40	¥640
			75	30	30	¥780
			100	20	20	¥1,060
			125	1	1	¥1,500
			150	1	1	¥1,800
	M437	水栓柱 角サドルバンド SUS	70角	20	20	¥1,620
			75角	20	20	¥1,820
	M437H	角サドルバンド SUS	60角	20	20	¥1,100
			70角	20	20	¥1,100
			75角	20	20	¥1,500
			80角	20	20	¥1,800
			90角	20	20	¥2,000
			100角	20	20	¥2,100
	M437L	足長水栓柱バンド	70角	20	20	¥1,620
	M437S	スライド型水栓柱バンド	60角	20	20	¥1,980
			70角	20	20	¥1,980

■水栓金具・ステンレス水栓柱・ガーデンパン





	品番	品名	サイズ	ケース入数	販売単位	標準価格		
	M652	アングル止水(本体)	1/2	5	5	¥2,950		
	M652D	ドライバー式アングル止水(本体)	1/2	5	5	¥2,960		
	M653G	外ネジ化粧バルブ(本体)	1/2	5	5	¥3,850		
	M654	化粧バルブ(本体)	1/2	5	5	¥3,240		
			3/4	5	5	¥5,610		
	M654D	ドライバー式化粧バルブ(本体)	1/2	5	5	¥3,010		
	M661	万能ホース水栓	1/2	40	2	¥3,300		
	M662	散水栓	1/2	40	2	¥3,300		
	M663	ステンレス 水栓柱	60×700	6	1	¥9,600		
			60×900	6	1	¥12,000		
			60×1200	6	1	¥14,000		
	M664	丸型ステンレスガーデンパン	Φ400	1	1	¥29,600		
		* 20ページをご参照ください。						



■配管部材

	品番	品名	サイズ	ケース入数	販売単位	標準価格
	M410	砲金ツギタシ	1/2×15	100	10	¥860
			1/2×20	80	10	¥980
			1/2×30	50	10	¥1,220
	M419L	公団型改良エルボ	1/2×1/2	10	10	¥6,600
			3/4×1/2	10	10	¥6,700
			3/4×3/4	10	10	¥8,220
	M419T	公団型改良チーズ	1/2×1/2	10	10	¥7,820
			3/4×1/2	10	10	¥7,820
	M418G	座付エルボ 外ネジ	13	100	10	¥1,850
	M418E	座付エルボ 内ネジ	13	100	10	¥1,900
	M421Z	砲金内外チーズ	13×1/2	150	10	¥1,520
			20×3/4	100	10	¥2,960
	M427	真鍮ホースニップル (タケノコ)	1/8×6	100	100	¥230
			1/8×8	100	100	¥230
			1/4×6	100	100	¥230
			1/4×8	100	100	¥250
			3/8×10.5	100	100	¥350
			1/2×10.5	100	50	¥500
			1/2×12	100	50	¥500
			1/2×14	100	50	¥540
			1/2×16	100	50	¥540
			3/4×16	50	20	¥880
			3/4×19	50	20	¥930
			1"×27	30	10	¥1,850
			1 1/4×34	10	5	¥3,170
			1 1/2×38	10	5	¥4,280
2"×52	10	5	¥7,540			
	A422	真鍮六角テーパースニップル (メッキ無)	1/2×1/2	100	100	¥330
	M422B	真鍮六角ニップル BS (メッキ無)	3/4×3/4	50	50	¥590
	A423	真鍮異型テーパースニップル (メッキ無)	1/2×3/4	50	50	¥610

■取付ビス

	品番	品名	サイズ	ケース入数	販売単位	標準価格
	M330	ステンレス化粧木ネジ	5.8×50	144	144	¥220
			6.2×63	144	144	¥260
			6.2×75	144	144	¥650
			6.2×100	1	1	¥1,000
	M334	洗濯流し取付木ネジ	W3/8×100	20	10	¥1,160
	M345	SUS皿頭AYボルト	M4(5/32)×38	50	50	¥220
			M5(3/16)×38	50	50	¥280
	M347	SUSなべ頭AYボルト	M4(5/32)×38	50	50	¥220
			M5(3/16)×38	50	50	¥280
	M362W	VP・VU兼用洋便器床フランジ	75・100	30	30	¥2,150

【 使用例 】

M664 丸形ステンレスガーデンパン



M863 散水栓ボックスユニット



給水管・蓋の開閉により蛇口の固定位置の変更が可能です。  
 ※水栓の取り付け方向に注意してください。





コンクリートを打設した場合の水抜き用パイプ(25mm)の接続が可能です。



※パイプはご用意ください。接続用の穴を25mmのホルソーで開けてください。

※取付使用についてはお問い合わせください。



■フレキチューブ

	品番	品名	サイズ	ケース入数	販売単位	標準価格	
	M610	フレキチューブ (SUS304 φ16.0)	1/2×100	100	10	¥720	
			1/2×150	100	10	¥770	
			1/2×200	100	10	¥790	
			1/2×250	100	10	¥840	
			1/2×300	100	10	¥890	
			1/2×350	100	10	¥980	
			1/2×400	100	10	¥1,080	
			1/2×450	100	10	¥1,100	
			1/2×500	100	10	¥1,120	
			1/2×600	50	10	¥1,260	
			1/2×700	50	10	¥1,480	
			1/2×800	50	10	¥1,680	
			1/2×900	50	10	¥1,860	
			1/2×1000	50	10	¥2,060	
	M610	フレキチューブ (SUS304 φ20)	3/4×150	100	10	¥1,160	
			3/4×200	100	10	¥1,350	
			3/4×250	100	10	¥1,430	
			3/4×300	100	10	¥1,620	
			3/4×350	100	10	¥1,740	
			3/4×400	100	10	¥1,920	
			3/4×450	100	10	¥1,990	
			3/4×500	100	10	¥2,200	
			3/4×600	50	10	¥2,470	
			3/4×700	50	10	¥2,770	
3/4×800	50	10	¥3,060				
3/4×900	50	10	¥3,080				
3/4×1000	50	10	¥3,660				
	M610S	フレキチューブ水協品 (SUS304 φ16.0)	1/2×100	100	10	¥780	
			1/2×150	100	10	¥830	
			1/2×200	100	10	¥880	
			1/2×250	100	10	¥960	
			1/2×300	100	10	¥990	
			1/2×350	100	10	¥1,040	
			1/2×400	100	10	¥1,140	
			1/2×450	100	10	¥1,200	
			1/2×500	100	10	¥1,240	
			1/2×600	100	10	¥1,380	
			1/2×700	100	10	¥1,580	
			1/2×800	50	10	¥1,740	
			1/2×900	50	10	¥1,920	
			1/2×1000	50	10	¥2,120	



■フレキチューブ

	品番	品名	サイズ	ケース入数	販売単位	標準価格
	M611	フレキチューブ (SUS316L φ16.8)	1/2×150	100	10	¥770
			1/2×200	100	10	¥850
			1/2×250	100	10	¥940
			1/2×300	100	10	¥970
			1/2×350	100	10	¥1,040
			1/2×400	100	10	¥1,100
			1/2×450	100	10	¥1,160
			1/2×500	100	10	¥1,240
			1/2×600	100	10	¥1,370
			1/2×700	50	10	¥1,560
			1/2×800	50	10	¥1,740
			1/2×900	50	10	¥1,940
			1/2×1000	50	10	¥2,150
			M611	フレキチューブ (SUS316L φ20)	3/4×150	100
	3/4×200	100			10	¥1,450
	3/4×250	100			10	¥1,550
	3/4×300	100			10	¥1,660
	3/4×350	100			10	¥1,780
	3/4×400	100			10	¥1,980
	3/4×450	100			10	¥2,120
	3/4×500	100			10	¥2,250
	3/4×600	50			10	¥2,560
3/4×700	50	10			¥2,760	
	M611S	フレキチューブ水協品 (SUS316L φ16.8)	1/2×150	100	10	¥830
			1/2×200	100	10	¥910
			1/2×250	100	10	¥1,000
			1/2×300	100	10	¥1,030
			1/2×350	100	10	¥1,100
			1/2×400	100	10	¥1,160
			1/2×450	100	10	¥1,220
			1/2×500	100	10	¥1,300
			1/2×600	50	10	¥1,430
			1/2×700	50	10	¥1,620
			1/2×800	50	10	¥1,800
			1/2×900	50	10	¥2,000
	1/2×1000	50	10	¥2,110		
	M611S	フレキチューブ水協品 (SUS316L φ20)	3/4×150	100	10	¥1,330
			3/4×200	100	10	¥1,510
			3/4×250	100	10	¥1,610
			3/4×300	100	10	¥1,720
			3/4×350	100	10	¥1,840
			3/4×400	100	10	¥2,040
			3/4×450	100	10	¥2,180
			3/4×500	100	10	¥2,310
			3/4×600	50	10	¥2,620
3/4×700			50	10	¥2,820	
3/4×800	50	10	¥3,050			
3/4×900	50	10	¥3,180			
3/4×1000	50	10	¥3,260			

■フレキチューブ

	品番	品名	サイズ	ケース入数	販売単位	標準価格
	M612	ファンコイルフレキチューブ	1/2×150	100	10	¥880
			1/2×200	100	10	¥1,000
			1/2×250	100	10	¥1,090
			1/2×300	100	10	¥1,230
			1/2×350	100	10	¥1,350
			1/2×400	100	10	¥1,460
			1/2×450	100	10	¥1,610
			1/2×500	100	10	¥1,770
			3/4×150	100	10	¥1,340
			3/4×200	100	10	¥1,470
			3/4×250	100	10	¥1,620
			3/4×300	100	10	¥1,740
			3/4×350	100	10	¥1,960
			3/4×400	100	10	¥2,120
			3/4×450	100	10	¥2,300
			3/4×500	100	10	¥2,440
			1"×150	50	5	¥2,700
			1"×200	50	5	¥3,100
			1"×250	50	5	¥3,300
			1"×300	50	5	¥3,470
1"×350	50	5	¥3,800			
1"×400	50	5	¥4,400			
1"×450	50	5	¥4,300			
1"×500	50	5	¥4,700			
	M634	フレキチューブ (ガイドナット付)	1/2×150	100	10	¥1,050
			1/2×200	100	10	¥1,070
			1/2×250	100	10	¥1,090
			1/2×300	100	10	¥1,160
			1/2×350	100	10	¥1,230
			1/2×400	100	10	¥1,270
			1/2×450	100	10	¥1,330
			1/2×500	100	10	¥1,380
	M613	異径フレキチューブ φ16.8 (20×13)	1/2×3/4×100	50	5	¥1,260
			1/2×3/4×150	50	5	¥1,290
			1/2×3/4×200	50	5	¥1,380
			1/2×3/4×300	50	5	¥1,400
			1/2×3/4×400	50	5	¥1,490
			1/2×3/4×500	50	5	¥1,660

■SUS製 継手

	S628	SUS304 フレキ用フクロナット	1/2×16	30	10	¥1,270
			1/2×16.8	30	10	¥1,270
			3/4×20	30	10	¥1,600
			1"×25	10	10	¥4,160
	S621	フレキ用ニップル (SUS 304)	1/2	100	10	¥1,140
			3/4	50	10	¥1,790
			1"	10	10	¥4,160
	S494	平行ニップル (SUS 304)	1/2	100	10	¥1,210
			3/4	50	10	¥1,850
			1"	10	10	¥4,550



■ストラップ・Pトラップ・部品

	品番	品名	サイズ	ケース入数	販売単位	標準価格	
	K110	横穴付Sトラップ	25	1	1	¥8,000	
			32	1	1	¥8,200	
	K112	大栓付Sトラップ(アフレ無)	25	1	1	¥8,100	
			32	1	1	¥9,000	
	K111	横穴付Pトラップ	25	1	1	¥7,200	
			32	1	1	¥7,400	
	K113	大栓付Pトラップ(アフレ無)	25	1	1	¥8,600	
			32	1	1	¥8,900	
	K522	片差込ソケット	25 × 300	10	10	¥3,080	
			32 × 300	10	10	¥3,190	
			32 × 500	10	10	¥3,960	
			38 × 300	10	10	¥4,400	
	K100	横穴用金物	25	10	10	¥2,530	
			32	10	10	¥2,760	
	K101	大栓金物(アフレ無)	25	10	10	¥2,760	
			32	10	10	¥2,900	
	K102	横穴用ゴム栓	25・32	10	10	¥640	
	K121	排水テール	25 × 300	10	10	¥1,570	
			25 × 400	10	10	¥2,160	
			25 × 500	10	10	¥2,530	
			32 × 300	10	10	¥2,070	
			32 × 400	10	10	¥2,640	
			32 × 500	10	10	¥2,880	
			32 × 700	10	10	¥4,490	
			38 × 300	10	10	¥2,420	
	K123	ポップアップ用ネジテール	32 × 200	10	10	¥2,530	
			32 × 300	10	10	¥3,040	

■U字管・ステッキ管





	品番	品名	サイズ	ケース入数	販売単位	標準価格	
	K127	トラップU管	25	10	10	¥3,180	
			32	10	10	¥3,960	
			38	10	10	¥8,460	
	K128	幅広U字管	25 × 140	1	1	¥7,580	
			32 × 100	1	1	¥8,340	
			32 × 140	1	1	¥8,700	
			32 × 180	1	1	¥9,680	
			38 × 140	1	1	¥11,500	
			38 × 180	1	1	¥12,200	
	K125B	トラップ用幅広ステッキ管	Φ25 × 140 × 550	1	1	¥6,400	
			Φ32 × 100 × 500	1	1	¥6,500	
			Φ32 × 140 × 500	1	1	¥7,000	
			Φ32 × 180 × 500	1	1	¥7,600	
			Φ38 × 140 × 500	1	1	¥9,800	
			Φ38 × 180 × 500	1	1	¥11,300	
	K125B	トラップ用幅広ステッキ管	Φ25 × 230 × 600	1	1	¥8,300	
			Φ32 × 230 × 500	1	1	¥8,450	
			Φ38 × 230 × 500	1	1	¥13,000	
	K129	立長U字管	25 × 112 × 90	10	10	¥9,200	
			32 × 140 × 98	10	10	¥9,780	

■トラップ用ステッキ管・キセル管

	品番	品名	サイズ	ケース入数	販売単位	標準価格	
	K125	トラップ用ステッキ管	25 × 530	10	10	¥2,900	
			25 × 620	10	10	¥3,950	
			25 × 730	10	10	¥4,560	
			32 × 470	10	10	¥3,340	
			32 × 550	10	10	¥4,000	
			32 × 600	10	10	¥4,900	
			32 × 700	10	10	¥5,100	
			32 × 750	10	10	¥5,220	
			38 × 390	10	10	¥5,500	
			38 × 500	10	10	¥5,730	
	K126	トラップ用キセル管	25 × 300	10	10	¥2,400	
			25 × 400	10	10	¥3,220	
			25 × 500	10	10	¥3,450	
			32 × 300	10	10	¥2,800	
			32 × 350	10	10	¥2,990	
			32 × 400	10	10	¥3,450	
			32 × 500	10	10	¥3,800	
			38 × 300	10	10	¥3,680	





■アングル直管・ヘリューズ管・部品

	品番	品名	サイズ	ケース入数	販売単位	標準価格	
	K210	アングル直管	13×300	10	10	¥860	
			13×400	10	10	¥1,210	
			13×500	1	1	¥1,530	
			13×1000	1	1	¥2,650	
	K212	アングルヘリューズ	13×300×5	10	10	¥1,010	
			13×300×10	10	10	¥1,010	
			13×300×15	10	10	¥1,010	
			13×300×20	10	10	¥1,160	
			13×300×25	10	10	¥1,190	
			13×300×30	10	10	¥1,220	
			13×300×35	10	10	¥1,250	
			13×300×40	10	10	¥1,290	
			13×300×45	10	10	¥1,310	
			13×300×50	10	10	¥1,440	
			13×300×60	10	10	¥1,460	
			13×300×65	10	10	¥1,480	
			13×300×70	10	10	¥1,560	
			13×300×75	10	10	¥1,580	
			13×300×80	10	10	¥1,600	
			13×300×90	10	10	¥1,680	
			13×300×100	10	10	¥1,700	
			13×400×15	10	10	¥2,100	
			13×500×15	10	10	¥2,200	
	PM756A	アングル用袋ナット(G1/2)	Φ13	10	10	¥300	
	PM759A	アングル用差込パッキン	Φ13	10	10	¥260	
	PK216	抜防止用ナットセット	Φ13	10	10	¥960	

■小使用直管・ヘリューズ

	品番	品名	サイズ	ケース入数	販売単位	標準価格	
	K260	小使用直管	16×300	10	10	¥1,100	
			16×400	10	10	¥1,660	
			16×500	10	10	¥1,800	
	K261	小使用ヘリューズ	16×300×10	10	10	¥1,370	
			16×300×15	10	10	¥1,470	
			16×300×20	10	10	¥1,520	
			16×300×25	10	10	¥1,520	
			16×300×30	10	10	¥1,520	
			16×300×35	10	10	¥1,520	
			16×300×40	10	10	¥1,520	
			16×300×45	10	10	¥1,760	
			16×300×50	10	10	¥1,870	
			16×300×60	10	10	¥1,980	
			16×300×70	10	10	¥2,040	
			16×300×75	10	10	¥2,040	
			16×300×80	10	10	¥2,090	
			16×300×90	10	10	¥2,150	
16×300×100	10	10	¥2,270				
	K264	小使用Z管	16×10×160	10	1	¥5,140	
			16×15×160	10	1	¥5,140	
			16×20×160	10	1	¥5,140	
			16×25×160	10	1	¥5,140	
			16×30×160	10	1	¥5,140	
			16×35×160	10	1	¥5,140	
			16×40×160	10	1	¥5,140	
			16×50×160	10	1	¥5,140	
			16×60×160	10	1	¥5,140	
			16×65×160	10	1	¥5,140	
			16×70×160	10	1	¥5,140	
			16×75×160	10	1	¥5,140	
			16×80×160	10	1	¥5,140	
			16×85×160	10	1	¥5,140	
	PM756S	小使用袋ナット(W24山16)	16用	10	10	¥320	
	PM759S	小使用差込パッキン	16用	10	10	¥260	
	PK216	抜防止用ナットセット	Φ16	10	10	¥1,200	

■ロータンク給水管

	品番	品名	サイズ	ケース入数	販売単位	標準価格
	K211	ロータンク給水L管	13×30×500	20	10	¥1,820
			13×35×500	20	10	¥1,870
			13×40×500	20	10	¥1,870
			13×45×500	20	10	¥2,090
			13×50×500	20	10	¥2,090
			13×55×500	20	10	¥2,090
			13×55×1000	20	10	¥3,410
			13×60×500	20	10	¥2,090
			13×65×500	20	10	¥2,090
			13×70×500	20	10	¥2,090
			13×75×500	20	10	¥2,180
			13×80×500	20	10	¥2,180
			13×85×500	20	10	¥2,180
			13×90×500	20	10	¥2,180
			13×95×500	20	10	¥2,180
			13×100×500	20	10	¥2,250
			13×110×500	10	10	¥2,310
			13×115×500	10	10	¥2,310
			13×120×500	10	10	¥2,310
			13×125×500	10	10	¥2,310
			13×130×500	10	10	¥2,310
			13×135×500	10	10	¥2,310
			13×140×500	10	10	¥2,510
			13×145×500	10	10	¥2,510
			13×150×500	10	10	¥2,510
			13×200×500	1	1	¥2,640
	K211P	ロータンク給水P管	13×0×500	1	1	¥3,630
			13×10×500	1	1	¥3,630
			13×20×500	1	1	¥3,630
			13×25×500	1	1	¥3,630

■シールワン

	品番	品名	サイズ	ケース入数	販売単位	標準価格
	K150	アングル用シールワン	20.5×15	50	50	¥330
			20.5×25	100	10	¥870
			20.5×30	100	10	¥880
			20.5×35	100	10	¥1,040
			20.5×40	50	10	¥1,100
			20.5×50	50	10	¥1,210
			20.5×70	60	1	¥3,800
			20.5×100	10	1	¥8,050
	K154	トラップ用シールワン	25×15	500	50	¥460
			25×25	100	10	¥1,000
			25×30	100	10	¥1,020
			25×40	100	10	¥1,080
			25×50	100	10	¥1,460
			25×60	50	10	¥1,830
			25×70	10	1	¥3,200
			32×15	100	10	¥460
			32×25	100	10	¥1,000
			32×30	100	10	¥1,040
			32×40	100	10	¥1,160
			32×50	100	10	¥1,470
			32×70	10	1	¥3,360
			32×100	10	1	¥9,500
			38×15	100	10	¥740
			38×25	100	10	¥1,240
			38×30	100	10	¥1,280
			38×40	100	10	¥1,480
			38×50	100	10	¥1,600
			38×60	10	1	¥4,370
38×70	10	1	¥5,980			

■給水管 FVニップル

	品番	品名	サイズ	ケース入数	販売単位	標準価格
	K220	アングル止水取付ニップル (給水管)	1/2×30	50	50	¥520
			1/2×35	50	50	¥540
			1/2×40	50	50	¥630
			1/2×45	50	50	¥650
			1/2×50	40	40	¥690
			1/2×55	40	40	¥710
			1/2×60	40	40	¥760
			1/2×65	40	40	¥760
			1/2×70	40	40	¥760
			1/2×75	40	40	¥760
			1/2×80	40	40	¥880
			1/2×85	40	40	¥900
			1/2×90	40	40	¥1,000
			1/2×95	40	40	¥1,020
			1/2×100	20	20	¥1,020
			1/2×105	20	20	¥1,160
			1/2×110	20	20	¥1,220
			1/2×115	20	20	¥1,300
			1/2×120	20	20	¥1,310
			1/2×125	20	20	¥1,310
			1/2×130	20	20	¥1,380
			1/2×135	20	20	¥1,420
			1/2×140	20	20	¥1,460
			1/2×145	20	20	¥1,480
			1/2×150	20	20	¥1,500
			1/2×160	20	20	¥1,840
			1/2×170	20	20	¥1,880
			1/2×175	20	20	¥1,900
			1/2×180	20	20	¥1,940
			1/2×185	20	20	¥1,960
			1/2×190	20	20	¥2,000
			1/2×200	10	10	¥2,100
1/2×210	10	10	¥2,160			
1/2×220	10	10	¥2,260			
1/2×230	10	10	¥2,400			
1/2×240	10	10	¥2,500			
1/2×250	10	10	¥2,580			
1/2×260	10	10	¥2,620			
1/2×270	10	10	¥2,840			
1/2×280	10	10	¥2,900			
1/2×290	10	10	¥2,980			
1/2×300	10	10	¥3,000			

■給水管 FVニップル

	品番	品名	サイズ	ケース入数	販売単位	標準価格
	K220	アングル止水取付ニップル (給水管)	1/2×310	10	10	¥3,200
			1/2×320	10	10	¥3,320
			1/2×330	10	10	¥3,380
			1/2×340	10	10	¥3,420
			1/2×350	10	10	¥3,500
			1/2×360	10	10	¥3,630
			1/2×370	10	10	¥3,740
			1/2×380	10	10	¥3,900
			1/2×400	10	10	¥4,000
			1/2×410	10	10	¥4,050
			1/2×420	10	10	¥4,100
			1/2×425	10	10	¥4,200
			1/2×440	10	10	¥4,420
			1/2×450	10	10	¥4,530
			1/2×465	10	10	¥4,790
			1/2×470	10	10	¥4,810
			1/2×500	10	10	¥4,900
			1/2×520	10	10	¥5,520
			1/2×530	10	10	¥5,760
			1/2×550	10	10	¥6,020
			1/2×570	10	10	¥6,400
			1/2×600	10	10	¥6,600
			1/2×700	10	10	¥7,020
	1/2×800	10	10	¥8,000		
	1/2×900	10	10	¥8,960		
	1/2×1000	10	10	¥9,800		
	1/2×1500	10	10	¥17,800		
	1/2×1800	10	10	¥21,600		
S220	SUS製 アングル止水取付ニップル	1/2×75	10	10	¥1,300	
		1/2×100	10	10	¥1,610	
		1/2×250	10	10	¥3,170	
		1/2×300	10	10	¥3,690	
		1/2×420	10	10	¥6,200	

■給水管 FVニップル

	品番	品名	サイズ	ケース入数	販売単位	標準価格
	K221	アングル止水取付ニップル	3/4×40	1	1	¥1,200
			3/4×50	1	1	¥1,310
			3/4×70	1	1	¥1,380
			3/4×75	1	1	¥1,410
			3/4×100	1	1	¥2,000
			3/4×120	1	1	¥2,310
			3/4×150	1	1	¥2,880
			3/4×200	1	1	¥3,240
			3/4×250	1	1	¥4,140
			3/4×300	1	1	¥5,100
			3/4×350	1	1	¥6,340
			3/4×400	1	1	¥6,900
			3/4×500	1	1	¥8,800
			3/4×1000	1	1	¥17,000
	K250	FV用給水ニップル	1"×40	10	1	¥1,280
			1"×45	10	1	¥1,400
			1"×50	10	1	¥1,500
			1"×55	10	1	¥1,670
			1"×60	10	1	¥1,730
			1"×65	10	1	¥1,780
			1"×70	10	1	¥1,780
			1"×75	10	1	¥1,870
			1"×80	10	1	¥1,910
			1"×85	10	1	¥1,980
			1"×90	10	1	¥2,020
			1"×95	10	1	¥2,080
			1"×100	10	1	¥2,130
			1"×105	10	1	¥2,180
			1"×110	10	1	¥2,300
			1"×115	10	1	¥2,350
			1"×120	10	1	¥2,420
			1"×125	10	1	¥2,460
			1"×130	10	1	¥2,540
			1"×135	10	1	¥2,640
1"×140	10	1	¥2,700			
1"×145	10	1	¥2,800			
1"×150	10	1	¥2,850			

■給水管 FVニップル

	品番	品名	サイズ	ケース入数	販売単位	標準価格
	K250	FV用給水ニップル	1" × 155	10	1	¥2,950
			1" × 160	10	1	¥3,390
			1" × 165	10	1	¥3,470
			1" × 170	10	1	¥3,560
			1" × 180	10	1	¥3,620
			1" × 190	10	1	¥3,720
			1" × 200	10	1	¥3,800
			1" × 210	5	1	¥4,090
			1" × 220	5	1	¥4,230
			1" × 230	5	1	¥4,510
			1" × 240	5	1	¥4,620
			1" × 245	5	1	¥4,700
			1" × 250	5	1	¥4,750
			1" × 260	5	1	¥4,900
			1" × 270	5	1	¥5,040
			1" × 280	5	1	¥5,140
			1" × 290	5	1	¥5,280
			1" × 300	5	1	¥5,510
			1" × 310	5	1	¥6,150
			1" × 320	5	1	¥6,470
			1" × 330	5	1	¥6,700
			1" × 350	5	1	¥6,820
			1" × 400	5	1	¥7,630
			1" × 450	5	1	¥8,060
			1" × 500	5	1	¥9,050
			1" × 510	5	1	¥9,300
			1" × 515	5	1	¥9,350
			1" × 525	5	1	¥9,370
			1" × 540	5	1	¥9,910
			1" × 610	5	1	¥11,780
1" × 620	5	1	¥12,000			
1" × 640	5	1	¥12,200			
1" × 670	5	1	¥12,770			
1" × 700	5	1	¥13,200			
1" × 725	5	1	¥13,800			



■ベンド管・洗浄管

	品番	品名	サイズ	ケース入数	販売単位	標準価格	
	K530	ベンド管	32×170×320	20	10	¥2,750	
			32×270×320	20	10	¥3,520	
			32×300×500	20	10	¥4,290	
			32×350×470	20	10	¥4,290	
			32×500×500	10	10	¥6,490	
			32×600×600	10	10	¥8,100	
	K531	ベンド管	38×200×320	20	10	¥4,070	
			38×300×500	20	10	¥5,390	
			38×350×470	20	10	¥5,390	
			38×500×500	20	10	¥7,150	
			38×600×600	10	10	¥8,030	
	K533	ロータンク右付ベンド管	38×300×400	10	10	¥8,030	
	K534	ロータンク左付ベンド管	38×300×400	10	10	¥8,030	
	K563	洗浄管(直)	25×1000	1	1	¥10,560	
			32×1000	1	1	¥10,780	
			38×1000	1	1	¥12,980	
			50×600	1	1	¥10,450	

■差込バンド管

	品番	品名	サイズ	ケース入数	販売単位	標準価格	
	K509	差込バンド管	25×140×300	1	1	¥3,740	
	K510	差込バンド管	32×140×120	10	10	¥2,750	
			32×140×300	10	10	¥3,960	
	K511	差込バンド管	38×110×100	10	10	¥3,730	
			38×110×300	10	10	¥5,720	
		K512	LR兼用差込バンド管	38×110×100	10	10	¥4,510
38×110×200				10	10	¥6,600	
38×110×250				10	10	¥7,040	
38×110×300				10	10	¥7,040	
	K513	45° 差込バンド管	32×100×120	10	10	¥2,860	
			38×110×100	10	10	¥3,850	
	K514	LR兼用差込バンド管	32×140×120	10	10	¥4,840	

■洗浄管差込継手

	品番	品名	サイズ	ケース入数	販売単位	標準価格
	K500	差込エルボ	13	10	10	¥3,040
			16	10	10	¥3,200
			19	10	10	¥3,420
			25	10	10	¥3,700
			32	10	10	¥4,200
			38	10	10	¥5,510
			50	1	1	¥18,000
	K501	異径差込エルボ	19 × 16	1	1	¥4,700
			25 × 16	1	1	¥5,700
			25 × 19	1	1	¥6,100
			32 × 16	1	1	¥7,400
32 × 25			1	1	¥7,700	
	K502	45° 差込エルボ	25	1	1	¥4,530
			32	1	1	¥4,550
			38	1	1	¥6,900
	K503	差込チーズ	13	10	1	¥6,930
			16	10	1	¥7,590
			25	10	1	¥7,480
			32	10	1	¥8,140
			38	10	1	¥10,890
	K504	異径差込チーズ	19 × 19 × 16	1	1	¥6,930
			25 × 19 × 19	1	1	¥8,250
			25 × 25 × 16	1	1	¥8,360
			32 × 25 × 25	1	1	¥10,670
			32 × 32 × 16	1	1	¥10,780
			38 × 25 × 25	1	1	¥11,000
	K520	差込ソケット	13	10	10	¥2,310
			16	10	10	¥2,420
			19	10	10	¥2,640
			25	10	10	¥2,530
			32	10	10	¥2,530
			38	10	10	¥3,630
			50	1	1	¥17,000

■アダプター

	品番	品名	サイズ	ケース入数	販売単位	標準価格	
	K410	外ネジアダプター	Φ13×1/2	10	10	¥630	
			Φ16×1/2	10	10	¥1,160	
			Φ19×3/4	10	10	¥2,180	
			Φ25×1"	10	10	¥2,220	
			Φ25×1"1/4	10	10	¥2,700	
			Φ32×1"	10	10	¥4,680	
			Φ32×1"1/4	10	10	¥2,900	
			Φ32×1"1/2	10	10	¥3,200	
			Φ38×1"1/4	10	10	¥7,380	
			Φ38×1"1/2	10	10	¥8,280	
	K411	内ネジアダプター	Φ13×1/2	10	10	¥1,350	
			Φ16×1/2	10	10	¥1,450	
			Φ25×1"	10	10	¥4,680	
			Φ25×1"1/4	10	10	¥5,550	
			Φ32×1"	10	10	¥5,580	
			Φ32×1"1/4	10	10	¥6,700	
			Φ32×1"1/2	10	10	¥7,760	
	K411S	船舶アダプター	Φ13×1/2	10	10	¥1,360	
			Φ16×1/2	10	10	¥1,450	
	K412	DVアダプター	Φ25×40	100	10	¥1,400	
			Φ32×40	100	10	¥1,420	
			Φ38×40	100	10	¥1,790	
	K414	兼用アダプター	25×40	200	10	¥1,140	
			32×40	200	10	¥1,140	
			32×50	100	10	¥1,390	
			38×50	100	10	¥1,510	

■支持金具

	品番	品名	サイズ	ケース入数	販売単位	標準価格
	K580	支持バンド(頭)	13	10	10	¥1,170
			16	10	10	¥1,190
			19	10	10	¥1,190
			20.5	10	10	¥1,190
			21.2	10	10	¥1,190
			25	10	10	¥1,190
			27.2	10	10	¥1,290
			32	10	10	¥1,320
			32.5	10	10	¥1,320
			34	10	10	¥1,650
			38	10	10	¥1,650
			50	1	1	¥5,400
	K582	ネジ棒(メッキ無)	W1/4 × 500	10	10	¥1,790
			W1/4 × 1000	10	10	¥3,580
	K583	サヤ管	Φ 7.3 × 500	10	10	¥1,100
			Φ 7.3 × 1000	10	10	¥2,200
	K584	バンド皿	W1/4	10	10	¥990
	K587	調整バンド棒セット	W1/4 × 100	10	10	¥2,630
			W1/4 × 200	10	10	¥2,890
	K585	バンド棒(ナット付)	30mm	10	10	¥490
			35mm	10	10	¥490
			40mm	10	10	¥490
			45mm	10	10	¥510
			50mm	10	10	¥510
			60mm	10	10	¥590
			70mm	10	10	¥590
			80mm	10	10	¥590
			90mm	10	10	¥590

■自在吐水口

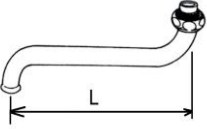
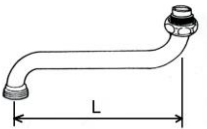
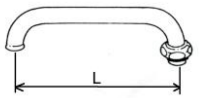
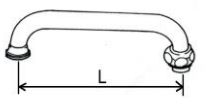
				
品番	K610	K611	K620	K621
品名	自在パイプ	泡沫自在パイプ	横自在パイプ	泡沫横自在パイプ
1/2×100	¥1,200	¥1,700		
1/2×120	¥1,200	¥1,700	¥1,300	¥1,800
1/2×170				
1/2×200	¥1,750	¥2,250	¥1,850	¥2,350
1/2×250	¥1,800	¥2,300	¥1,900	¥2,400
1/2×270				
1/2×300	¥2,300	¥2,800	¥2,400	¥2,900
1/2×350	¥3,900	¥4,400	¥4,000	¥4,500
1/2×400	¥4,500	¥5,000	¥4,600	¥5,100
1/2×450	¥4,800	¥5,300	¥4,900	¥5,400
1/2×500	¥5,500	¥6,100	¥5,600	

\*各ケース10本入り

3/4×100	¥2,700	¥3,200	¥2,800	¥3,300
3/4×120	¥2,700	¥3,200	¥2,800	¥3,300
3/4×170				
3/4×200	¥3,100	¥3,600	¥3,200	¥3,700
3/4×220				
3/4×250	¥3,450	¥3,950	¥3,550	¥4,050
3/4×270				
3/4×300	¥3,700	¥4,200	¥3,800	¥4,300
3/4×350	¥4,400	¥4,900	¥4,500	¥5,000
3/4×400	¥4,800	¥5,300	¥4,900	¥5,400
3/4×450	¥5,300	¥5,800	¥5,400	¥5,900
3/4×500	¥5,600	¥6,100	¥5,700	¥6,200

\*各ケース5本入り

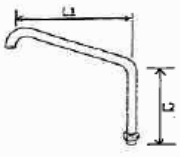
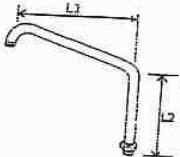
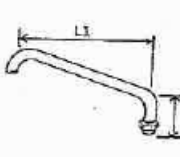
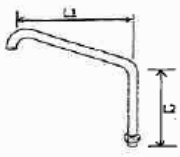
				
	*受注生産	*受注生産	*受注生産	*受注生産
品番	K623	K624	K625	K626
品名	T31型用パイプ	T131型用パイプ	T36型用パイプ	T136型用パイプ
1/2×190			¥1,500	¥2,000
1/2×220			¥1,800	¥2,300
1/2×250	¥2,600	¥3,100	¥1,900	¥2,400
1/2×300	¥3,000	¥3,500	¥2,400	¥2,900
1/2×350			¥2,900	¥3,400
1/2×400			¥3,300	¥3,800

\*各1本から

■サニタリー

	品番	品名	サイズ	ケース入数	販売単位	標準価格	
	K130	タオルリング		10	10	¥3,980	
	K131	タオルカケセット	19×360	1	1	¥2,540	
			19×450	1	1	¥2,980	
			19×600	1	1	¥3,300	
			19×1000	1	1	¥4,200	
	K135	ランドリー伸縮パイプセット	950-1800mm	2	2	¥5,900	
	K135F	ランドリーパイプ用フック		100	10	¥840	

K135 ランドリー伸縮パイプセット



- \* ユニットバス用のランドリーパイプセットで
- \* 950～1800mmでの伸縮が可能です。
- \* 付属品は取付(収納)のフック4個付です。
- \* 材質 SUS304

■手すり取付ビス類

	品番	品名	サイズ	ケース入数	販売単位	標準価格	
	PM334	洗濯流し取付木ネジ	W3/8×100	20	10	¥1,120	
	PK890	タッピンネジセット	Φ6×60	1	1	¥940	
	PK890B	タッピンネジセット	Φ6×50	1	1	¥750	
	PK891	AYボルトセット	M6×60	1	1	¥1,240	
	PK892	アンカーセット	M6×60	1	1	¥2,100	
	PK893	はさみ込みセット	M6×100	1	1	¥6,200	



■配管接続継手

	品番	品名	サイズ	ケース入数	販売単位	標準価格	
	PM458S	給湯器取付ニップル(普及)	3/4×1/2	50	50	¥880	
	PM459	接続ユニオン	1/2×1/2	10	10	¥1,140	
			3/4×1/2	10	10	¥2,200	
			3/4×3/4	10	10	¥1,600	
	PM460	両ナットユニオン	1/2×1/2	10	10	¥1,220	
			1/2×3/4	10	10	¥1,620	
			3/4×3/4	10	10	¥1,800	
	PM452	パネル継手	1/2	10	10	¥2,220	
	PM454	パネルショートエルボ(内ネジ)	1/2	10	10	¥3,300	
	PM454G	パネルショートエルボ(外ネジ)	1/2	10	10	¥3,300	
	PM640	分岐金具(ミガキ)	1/2×1/2	10	10	¥2,280	
	PM640B	分岐金具(二方ナット付)	1/2×1/2	10	10	¥2,800	
	PM641	逆分岐金具	3/4×1/2	10	10	¥2,750	
	PM642	ナット付エルボ(バフナシ)	1/2×1/2	10	10	¥1,820	
	PM642C	ナット付エルボ(ミガキ)	1/2×1/2	10	10	¥2,230	
	PM648B	分岐金具(バフナシ)		10	10	¥1,840	

■水栓部品

	品番	品名	サイズ	ケース入数	販売単位	標準価格	
	PM756A	アングル用袋ナット	13(G1/2)	10	10	¥330	
	PM756S	小使用袋ナット	16(W24山16)	10	10	¥440	
	PM759A	アングル用差込パッキン	13	10	10	¥270	
	PM759S	小使用差込パッキン	16	10	10	¥290	
	PM771	吐水口キャップ	W26山20	10	1	¥2,200	
	PM772	ハンドルキャップ	W24山20	10	1	¥2,200	
	PM490B	クロームメクラキャップ(BS)	1/2	50	10	¥590	
	PM431	水栓平ザガネ(SUS製)	50×22	10	10	¥690	
			50×29	10	10	¥720	
			65×22	10	10	¥990	
			80×22	10	10	¥1,950	
			100×22	10	10	¥3,100	
	PM431A		メクラプレート(BS) 10枚入り	Φ18×1t	10	10	¥780
メクラプレート(SUS)			Φ50×1t	10	10	¥630	
	PM440	混合栓用送りザガネ	45×15	10	10	¥1,580	
			45×20	10	10	¥2,050	
			45×25	10	10	¥2,370	
			45×30	10	10	¥3,260	
			45×35	10	10	¥3,770	
			60×15	10	10	¥2,220	
			60×20	10	10	¥2,680	
			60×30	10	10	¥3,600	
			80×10	10	10	¥3,880	
			80×20	10	10	¥4,490	
	PK614	自在用ナット	1/2(W26山20)	10	10	¥450	
			3/4(W30山20)	10	10	¥560	
	PK615	泡沫金具	1/2・3/4 (W22山20)	10	10	¥1,060	

■トラップ金具

	品番	品名	サイズ	ケース入数	販売単位	標準価格	
	PK123	ポップアップ用ネジテール	32 × 300	10	10	¥3,120	
	PK125	トラップ用ステッキ管	25 × 730	10	10	¥4,780	
			32 × 750	10	10	¥5,700	
	PK125B	幅広ステッキ	25 × 140 × 550	10	1	¥6,330	
			32 × 100 × 500	10	1	¥6,560	
			32 × 140 × 500	10	1	¥6,900	
			32 × 180 × 500	10	1	¥8,170	
	PK126	トラップ用Pキセル	25 × 500	10	1	¥3,570	
			32 × 500	10	1	¥4,030	
	PK127	トラップ用U管	25	10	1	¥3,450	
			32	10	1	¥4,140	
			38	10	1	¥6,210	
	PK128	幅広U字管	25 × 140	1	1	¥8,510	
			32 × 100	1	1	¥9,490	
			32 × 140	1	1	¥9,660	
			32 × 180	1	1	¥9,890	
	PK129	立長U字管	25 × 112 × 90	1	1	¥9,600	
			32 × 140 × 98	1	1	¥10,200	
	PK522	片差込ソケット	25 × 300	10	10	¥2,540	
			32 × 300	10	10	¥2,710	
			32 × 500	10	10	¥3,540	
			38 × 300	10	10	¥3,770	

■シールワン

	品番	品名	サイズ	ケース入数	販売単位	標準価格
	PK150	アングル用シールワン	20.5×25	10	1	¥670
			20.5×30	10	1	¥920
			20.5×40	10	1	¥1,020
			20.5×50	10	1	¥1,120
			20.5×70	10	1	¥4,110
			20.5×100	10	1	¥8,620
	PK154	トラップ用シールワン	25×30	10	1	¥1,010
			25×40	10	1	¥1,070
			25×50	10	1	¥1,250
			25×70	10	1	¥3,780
			32×25	10	1	¥850
			32×30	10	1	¥1,010
			32×35	10	1	¥1,070
			32×40	10	1	¥1,070
			32×50	10	1	¥1,210
			32×70	10	1	¥3,850
			32×100	10	1	¥7,920
			38×25	10	1	¥920
			38×30	10	1	¥1,010
			38×40	10	1	¥1,130
38×50	10	1	¥1,460			
	PK156	幅広シールワン	80×20.5×15	10	1	¥2,810
			80×25×15	10	1	¥2,920
			80×32×15	10	1	¥2,920
			80×38×15	10	1	¥2,920
			90×20.5×15	10	1	¥3,340
			90×25×15	10	1	¥3,340
			90×32×15	10	1	¥3,340
			90×38×15	10	1	¥3,340
			100×20.5×15	10	1	¥3,890
			100×25×15	10	1	¥3,890
			100×32×15	10	1	¥3,890
			100×38×15	10	1	¥3,890

■接続部材

	品番	品名	サイズ	ケース入数	販売単位	標準価格	
	PK151	排水用袋ナット	25(W32)	10	1	¥770	
			32(W38)	10	1	¥770	
			32(W40)	10	1	¥800	
			38(W45)	10	1	¥950	
			32(G1"1/4)	10	1	¥1,250	
			38(G1"1/2)	10	1	¥1,540	
	PK152	差込パッキン	25(W32)	1	1	¥320	
			32(W38)	1	1	¥360	
			32(W40)	1	1	¥380	
			38(W45)	1	1	¥390	
	PK153	排水用平パッキン	25(W32)	1	1	¥240	
			32(W38)	1	1	¥260	
			32(W40)	1	1	¥270	
			38(W45)	1	1	¥280	
	PM494	平行ニップル	1/2	10	10	¥440	
	PM621	フレキ用ニップル	1/2	10	10	¥330	
			3/4	10	10	¥490	
	PM621A	A型異径ニップル	3/4×1/2	10	10	¥590	
	PM621L	フレキ用エルボ	1/2	10	10	¥1,010	
			3/4	10	10	¥1,400	
	PM621T	フレキ用チーズ	1/2	10	10	¥1,050	
			3/4	10	10	¥1,380	

■レベルバンド

	品番	品名	サイズ	ケース入数	販売単位	標準価格	
	Y820	レベルバンド(SGP・VP用) ユニクロ	40×120H	50	50	¥620	
			50×120H	50	50	¥640	
			65×120H	40	40	¥660	
			80×120H	40	40	¥720	
			100×120H	30	30	¥870	
			40×150H	50	50	¥690	
			50×150H	50	50	¥760	
			65×150H	40	40	¥800	
			80×150H	40	40	¥840	
			100×150H	30	30	¥910	
			40×200H	30	30	¥920	
			50×200H	30	30	¥980	
			65×200H	30	30	¥1,070	
			80×200H	20	20	¥1,100	
100×200H	20	20	¥1,340				
	Y801	レベル調整バンド(耐火管用) 両フック	40×120H	50	50	¥840	
			50×120H	40	40	¥920	
			65×120H	40	40	¥990	
			80×120H	30	30	¥1,090	
			100×120H	20	20	¥1,210	
			40×150H	50	50	¥910	
			50×150H	40	40	¥990	
			65×150H	40	40	¥1,060	
			80×150H	30	30	¥1,110	
			100×150H	20	20	¥1,260	
				Y802	レベル調整バンド(フリー)	30-80×120H	50
30-80×150H	50	50				¥980	
30-80×200H	30	30				¥1,460	

■兼用タイプレベルバンド(GP管・耐火二層管)

	品番	品名	サイズ	ケース入数	販売単位	標準価格	
	Y821	兼用タイプレベルバンド ユニクロ	15-25 × 120H	60	60	¥710	
			32-50 × 120H	50	50	¥710	
			65-80 × 120H	40	40	¥750	
			100-125 × 120H	20	20	¥960	
			15-25 × 150H	60	60	¥730	
			32-50 × 150H	50	50	¥760	
			65-80 × 150H	40	40	¥830	
			100-125 × 150H	20	20	¥990	
			125-150 × 180H	15	15	¥2,900	
	YS821	兼用タイプレベルバンド ステンレス	15-25 × 120H	60	60	¥2,490	
			32-50 × 120H	50	50	¥2,660	
			65-80 × 120H	40	40	¥2,870	
			100-125 × 120H	20	20	¥3,540	
			15-25 × 150H	60	60	¥2,660	
			32-50 × 150H	50	50	¥2,770	
			65-80 × 150H	40	40	¥3,000	
			100-125 × 150H	20	20	¥3,690	
	Y890	レベルバンド締付レンチ	17mm 六角	100	10	¥900	
 22mm	Y891	保護キャップ(10個入)	3/8用	10P	1P	¥790	

兼用タイプレベルバンド 適応管サイズ		
	GP管	耐火二層管
S	15A~25A	
A	32A~50A	40A
B	65A~80A	50A~65A
C	100A~125A	75A~100A
D	125A~150A	

■吊バンド・立バンド





	品番	品名	サイズ	ケース入数	販売単位	標準価格			
	Y824G	ユニクロ蝶番式吊バンドタン付	15A	150	50	¥220			
			20A	120	40	¥230			
			25A	100	30	¥230			
			32A	90	30	¥240			
			40A	80	30	¥240			
			50A	70	30	¥260			
			65A	50	20	¥290			
			80A	40	20	¥370			
			100A	30	20	¥420			
			125A	20	10	¥1,060			
			150A	20	10	¥1,190			
			200A	10	5	¥2,620			
			250A	10	5	¥4,620			
			300A	10	5	¥6,780			
			350A	10	5	¥9,770			
	YS824G	ステン蝶番式吊バンドタン付	15A	150	50	¥770			
			20A	120	40	¥790			
			25A	100	30	¥820			
			32A	90	30	¥990			
			40A	80	30	¥1,040			
			50A	70	30	¥1,100			
			65A	50	20	¥1,320			
			80A	40	20	¥1,370			
			100A	30	20	¥1,510			
			125A	20	10	¥3,740			
			150A	20	10	¥4,340			
			200A	10	5	¥5,720			
			250A	10	5	¥12,160			
			300A	10	5	¥14,080			
				Y825G	ユニクロ蝶番式立バンドBN付	15A	200	100	¥150
20A	150	80				¥150			
25A	130	50				¥160			
32A	120	50				¥170			
40A	100	50				¥170			
50A	70	30				¥190			
65A	50	20				¥240			
80A	40	20				¥270			
100A	30	20				¥310			
125A	20	10				¥730			
150A	20	10				¥940			
200A	10	10				¥1,980			
	YS825G	ステン蝶番式立バンドBN付				15A	200	100	¥420
						20A	150	80	¥450
						25A	130	50	¥480
			32A	120	50	¥580			
			40A	100	50	¥600			
			50A	70	30	¥660			
			65A	50	20	¥710			
			80A	40	20	¥770			
			100A	30	20	¥880			
			125A	20	10	¥2,390			
			150A	20	10	¥2,760			
			200A	10	5	¥4,250			







■組式G・VP立バンド

	品番	品名	サイズ	ケース入数	販売単位	標準価格
	Y826G	ユニクロ組式立バンドBN付	15A	200	200	¥60
			20A	160	160	¥70
			25A	150	150	¥80
			32A	130	130	¥110
			40A	120	120	¥120
			50A	120	120	¥130
			65A	80	80	¥200
			80A	60	60	¥240
			100A	40	40	¥310
			125A	20	20	¥560
			150A	10	10	¥730
	YS826G	ステン組式立バンドBN付	15A	200	200	¥350
			20A	160	160	¥370
			25A	150	150	¥380
			32A	130	130	¥450
			40A	120	120	¥480
			50A	120	120	¥500
			65A	80	80	¥880
			80A	60	60	¥960
			100A	40	40	¥1,040
			125A	20	20	¥2,810
			150A	10	10	¥4,940
	Y827V	ユニクロVP立バンドBN付	13A	200	200	¥70
			16A	180	180	¥70
			20A	160	160	¥70
			25A	140	140	¥80
			30A	120	120	¥90
			40A	100	100	¥100
			50A	80	80	¥110
			65A	50	50	¥160
			80A	40	40	¥170
			100A	25	25	¥190
	YS827V	ステンVP立バンドBN付	13A	200	200	¥220
			16A	180	180	¥230
			20A	160	160	¥230
			25A	140	140	¥250
			30A	120	120	¥280
			40A	100	100	¥290
			50A	80	80	¥310
			65A	50	50	¥420
			80A	40	40	¥420
			100A	25	25	¥580





■吊バンド

	品番	品名	サイズ	ケース入数	販売単位	標準価格
	Y828G	ユニクロ組式吊バンドタン付  * 125A以上は Y824G蝶番式をお使いください。	15A	150	150	¥90
			20A	130	130	¥100
			25A	120	120	¥100
			32A	120	120	¥130
			40A	100	100	¥150
			50A	80	80	¥160
			65A	70	70	¥230
			80A	50	50	¥260
			100A	50	50	¥350
	YS828G	ステン組式吊バンドタン付  * 125A以上は YS824G蝶番式をお使いください。	15A	150	150	¥610
			20A	130	130	¥630
			25A	120	120	¥650
			32A	120	120	¥670
			40A	100	100	¥700
			50A	80	80	¥720
			65A	70	70	¥1,080
			80A	50	50	¥1,140
			100A	50	50	¥1,240
	Y829V	ユニクロVP吊バンドタン付	13A	200	200	¥120
			16A	160	160	¥130
			20A	140	140	¥130
			25A	120	120	¥140
			30A	120	120	¥170
			40A	100	100	¥180
			50A	80	80	¥180
			65A	40	40	¥200
			80A	40	40	¥240
			100A	20	20	¥280
	YS829V	ステンVP吊バンドタン付	13A	200	200	¥470
			16A	160	160	¥470
			20A	140	140	¥480
			25A	120	120	¥500
			30A	120	120	¥550
			40A	100	100	¥560
			50A	80	80	¥590
			65A	40	40	¥770
			80A	40	40	¥830
			100A	20	20	¥890

■吊・立バンド ドブ

	品番	品名	サイズ	ケース入数	販売単位	標準価格
	Y873G	GP管用 蝶番式吊バンドタン付ドブ	15A	150	10	¥490
			20A	130	10	¥490
			25A	120	10	¥500
			32A	120	10	¥520
			40A	90	10	¥530
			50A	70	10	¥560
			65A	50	10	¥640
			80A	30	10	¥710
			100A	20	10	¥850
			125A	10	10	¥1,960
			150A	10	10	¥2,210
	Y874G	GP管用 蝶番式立バンドBN付ドブ	15A	200	10	¥290
			20A	170	10	¥300
			25A	150	10	¥310
			32A	140	10	¥340
			40A	100	10	¥350
			50A	70	10	¥380
			65A	50	10	¥470
			80A	30	10	¥530
			100A	20	10	¥590
			125A	10	10	¥1,210
			150A	10	10	¥1,410
	Y875G	GP管用 Uバンド ドブ	20A	250	10	¥980
			25A	200	10	¥1,010
			32A	180	10	¥1,080
			40A	150	10	¥1,120
			50A	120	10	¥1,140
			65A	120	10	¥1,240
			80A	100	10	¥1,320
			100A	80	10	¥1,390
			125A	40	10	¥2,240
			150A	30	10	¥2,710
	Y876	2つ穴T字足 ドブ	25 × 60	100	10	¥420
			25 × 75	100	10	¥460
			25 × 90	100	10	¥520
			25 × 100	100	10	¥530
	Y878	Uボルト ドブ	3/8 × 15A	250	10	¥330
			3/8 × 20A	200	10	¥340
			3/8 × 25A	200	10	¥360
			3/8 × 32A	150	10	¥390
			3/8 × 40A	150	10	¥420
			3/8 × 50A	100	10	¥440
			3/8 × 65A	100	10	¥570
			3/8 × 80A	100	10	¥620
3/8 × 100A	40	10	¥750			





■Uボルト SU管用デップバンド

	品番	品名	サイズ	ケース入数	販売単位	標準価格
	Y781	ユニクロメッキ Uボルト	W3/8×15A	250	30	¥100
			W3/8×20A	200	30	¥100
			W3/8×25A	200	30	¥110
			W3/8×32A	150	30	¥120
			W3/8×40A	150	30	¥130
			W3/8×50A	100	30	¥140
			W3/8×65A	100	30	¥170
			W3/8×80A	100	30	¥200
			W3/8×100A	40	30	¥220
			W3/8×125A	20	10	¥430
			W3/8×150A	20	10	¥460
	YS781	ステンレス Uボルト	W3/8×15A	250	20	¥350
			W3/8×20A	200	20	¥380
			W3/8×25A	200	20	¥410
			W3/8×32A	150	20	¥480
			W3/8×40A	150	20	¥520
			W3/8×50A	100	20	¥580
			W3/8×65A	100	20	¥680
			W3/8×80A	100	20	¥730
			W3/8×100A	40	20	¥900
			W3/8×125A	20	10	¥1,090
			W3/8×150A	20	10	¥1,210
	YD781	ユニクロ SU管用 デップ Uボルト	SU13	250	10	¥240
			SU20	230	10	¥270
			SU25	200	10	¥290
			SU30	200	10	¥370
			SU40	180	10	¥420
			SU50	150	10	¥450
			SU60	100	10	¥530
			SU75	80	10	¥680
			SU80	70	10	¥740
			SU100	50	10	¥850
	YD826	ユニクロ SU管用 デップ 吊バンド	SU13	250	10	¥300
			SU20	200	10	¥320
			SU25	200	10	¥330
			SU30	180	10	¥350
			SU40	130	10	¥390
			SU50	120	10	¥420
			SU60	120	10	¥520
			SU75	100	10	¥690
			SU80	80	10	¥830
			SU100	50	10	¥910
	YD827	ユニクロ SU管用 デップ 立バンド	SU13	450	10	¥230
			SU20	200	10	¥250
			SU25	200	10	¥290
			SU30	180	10	¥310
			SU40	130	10	¥350
			SU50	120	10	¥370
			SU60	120	10	¥430
			SU75	100	10	¥570
			SU80	80	10	¥690
			SU100	50	10	¥800





■Uバンド

	品番	品名	サイズ	ケース入数	販売単位	標準価格
	Y830	ユニクロ GP管用Uバンド	20A	250	10	¥360
			25A	200	10	¥370
			32A	180	10	¥390
			40A	150	10	¥410
			50A	120	10	¥430
			65A	120	10	¥520
			80A	100	10	¥540
			100A	80	10	¥610
			125A	40	10	¥1,150
			150A	30	10	¥1,250
			200A	20	10	¥1,430
			250A	-	-	*受注生産
			300A	-	-	*受注生産
	YS830	SUS GP管用Uバンド	20A	250	10	¥1,120
			25A	200	10	¥1,160
			32A	180	10	¥1,190
			40A	150	10	¥1,260
			50A	120	10	¥1,350
			65A	120	10	¥1,580
			80A	100	10	¥1,690
			100A	80	10	¥1,760
			125A	40	10	¥3,410
			150A	30	10	¥3,600
			200A	20	10	¥4,180
			250A	-	-	*受注生産
			300A	-	-	*受注生産
	Y835	ユニクロ 二層管用Uバンド	40A	100	10	¥460
			50A	100	10	¥480
			65A	80	10	¥540
			80A	80	10	¥560
			100A	70	10	¥590
			125A	40	10	¥1,040
			150A	30	10	¥1,180
	YS835	SUS 二層管用Uバンド	40A	100	10	¥1,760
			50A	100	10	¥1,820
			65A	80	10	¥1,870
			80A	80	10	¥1,940
			100A	70	10	¥2,040
			125A	40	10	¥3,960
			150A	30	10	¥4,490



■アングル

	品番	品名	サイズ	ケース入数	販売単位	標準価格	
	Y110U	40Wユニクロアングル 両穴釘穴付	40W x 1800L	5	5	¥2,420	
			40W x 2100L	5	5	¥2,690	
			40W x 2400L	5	5	¥2,770	
	YS110	40Wステンレスアングル 両穴釘穴付	40W x 1800L	5	5	¥9,270	
			40W x 2100L	5	5	¥11,190	
			40W x 2400L	5	5	¥12,200	
	Y160U	40Wユニクロアングル 両穴釘穴付	40W x 1800L	5	5	¥2,420	
			40W x 2400L	5	5	¥2,770	
			40W x 2550L	5	5	¥3,080	
	YS160	40Wステンレスアングル 両穴釘穴付	40W x 1800L	5	5	¥9,270	
			40W x 2400L	5	5	¥11,190	
			40W x 2550L	5	5	¥14,580	
	Y150U	40Wユニクロアングル 両穴釘穴無し	40W x 2100L	5	5	¥3,340	
			40W x 2400L	5	5	¥3,980	
	Y150D	40Wドブアングル 両穴釘穴無し	40W x 1800L	5	5	¥3,910	
			40W x 2400L	5	5	¥4,780	
	YS150	40Wステンレスアングル 両穴釘穴無し	40W x 2100L	5	5	¥14,240	
			40W x 2400L	5	5	¥15,140	
	Y155U	40Sユニクロアングル 片穴釘穴無し	40S x 2100L	5	5	¥3,660	
			40S x 2400L	5	5	¥3,820	
	Y155D	40Sドブアングル 片穴釘穴無し	40S x 1800L	5	5	¥3,830	
			40S x 2400L	5	5	¥4,660	
	YS155	40Sステンレスアングル 片穴釘穴無し	40S x 2100L	5	5	¥14,460	
			40S x 2400L	5	5	¥15,370	
	Y120U	50Wユニクロアングル 両穴釘穴無し	50W x 2100L	5	1	¥6,020	
			50W x 2400L	5	1	¥7,080	
	YS120	50Wステンレスアングル 両穴釘穴無し	50W x 2100L	5	1	¥21,360	
			50W x 2400L	5	1	¥26,080	
	Y121U	50Sユニクロアングル 片穴釘穴無し	50S x 2100L	5	1	¥6,020	
			50S x 2400L	5	1	¥7,080	
	YS121	50Sステンレスアングル 片穴釘穴無し	50S x 2100L	5	1	¥21,360	
			50S x 2400L	5	1	¥26,080	
	Y180	フラットバー ユニクロ	38 x 1200	5	5	¥1,790	
			38 x 1800	5	5	¥2,020	
	Y180D	フラットバー ドブ	38 x 1800	5	5	¥2,370	
	YS180	フラットバー ステンレス	38 x 1800	5	5	¥5,960	

■カッタングル

	品番	品名	サイズ	ケース入数	販売単位	標準価格
	Y110K	40Wユニクロアングル 両穴釘穴付	40W x 300L	10	10	¥940
			40W x 500L	10	10	¥1,150
			40W x 700L	10	10	¥1,590
			40W x 900L	10	10	¥1,860
	YS110K	40Wステンレスアングル 両穴釘穴付	40W x 300L	10	10	¥2,510
			40W x 500L	10	10	¥3,270
			40W x 700L	10	10	¥4,420
			40W x 900L	10	10	¥5,740
	Y150K	40Wユニクロアングル 両穴釘穴無し	40W x 300L	10	10	¥940
			40W x 500L	10	10	¥1,150
			40W x 700L	10	10	¥1,590
			40W x 900L	10	10	¥1,860
	YS150K	40Wステンレスアングル 両穴釘穴無し	40W x 300L	10	10	¥2,510
			40W x 500L	10	10	¥3,270
			40W x 700L	10	10	¥4,420
			40W x 900L	10	10	¥5,740
	Y155K	40Sユニクロアングル 片穴釘穴無し	40S x 300L	10	10	¥960
			40S x 500L	10	10	¥1,180
			40S x 700L	10	10	¥1,610
			40S x 900L	10	10	¥1,880
	YS155K	40Sステンレスアングル 片穴釘穴無し	40S x 300L	10	10	¥2,620
			40S x 500L	10	10	¥3,390
			40S x 700L	10	10	¥4,610
			40S x 900L	10	10	¥6,030
	Y120K	50Wユニクロアングル 両穴釘穴無し	50W x 300L	5	5	¥1,130
			50W x 500L	5	5	¥1,980
			50W x 700L	5	5	¥2,960
			50W x 900L	5	5	¥3,580
	YS120K	50Wステンレスアングル 両穴釘穴無し	50W x 300L	5	5	¥3,490
			50W x 500L	5	5	¥5,590
			50W x 700L	5	5	¥7,220
			50W x 900L	5	5	¥9,890
	Y121K	50Sユニクロアングル 片穴釘穴無し	50S x 300L	5	5	¥1,130
			50S x 500L	5	5	¥1,980
			50S x 700L	5	5	¥2,960
			50S x 900L	5	5	¥3,580
	YS121K	50Sステンレスアングル 片穴釘穴無し	50S x 300L	5	5	¥3,630
			50S x 500L	5	5	¥5,850
			50S x 700L	5	5	¥7,570
			50S x 900L	5	5	¥10,350

■40Sブラケット

	品番	品名	サイズ	ケース入数	販売単位	標準価格	
	Y210	40Sユニクロブラケット 片穴釘穴付	L-1 (150×120)	10	10	¥620	
			L-2 (210×150)	10	10	¥680	
			L-3 (300×210)	10	10	¥850	
			L-4 (390×240)	10	10	¥1,190	
			L-5 (510×300)	10	10	¥1,360	
			L-6 (600×300)	10	10	¥1,580	
			L-7 (690×390)	10	10	¥1,990	
			L-8 (810×390)	10	10	¥2,270	
			L-9 (900×510)	10	10	¥2,830	
	Y210	40Sステンレスブラケット 片穴釘穴付	L-1 (150×120)	10	10	¥1,590	
			L-2 (210×150)	10	10	¥1,960	
			L-3 (300×210)	10	10	¥2,850	
			L-4 (390×240)	10	10	¥3,700	
			L-5 (510×300)	10	10	¥4,620	
			L-6 (600×300)	10	10	¥4,880	
			L-7 (690×390)	10	10	¥6,250	
			L-8 (810×390)	10	10	¥7,260	
			L-9 (900×510)	10	10	¥8,200	
	Y210D	40Sドブメッキブラケット 片穴釘穴付	L-1 (150×120)	10	10	¥1,110	
			L-2 (210×150)	10	10	¥1,360	
			L-3 (300×210)	10	10	¥1,730	
			L-4 (390×240)	10	10	¥2,250	
			L-5 (510×300)	10	10	¥2,740	
			L-6 (600×300)	10	10	¥2,940	
			L-7 (690×390)	10	10	¥3,640	
			L-8 (810×390)	10	10	¥3,800	
			L-9 (900×510)	10	10	¥4,540	
	Y229	エンドキャップ	40巾用	100	10	¥150	
			50巾用	100	10	¥250	



■40Wブラケット

	品番	品名	サイズ	ケース入数	販売単位	標準価格	
	Y220U	40Wユニクロブラケット 両穴釘穴付	L-1 (150×120)	10	10	¥810	
			L-2 (210×150)	10	10	¥910	
			L-3 (300×210)	10	10	¥1,150	
			L-4 (390×240)	10	10	¥1,550	
			L-5 (510×300)	10	10	¥1,810	
			L-6 (600×300)	10	10	¥2,080	
			L-7 (690×390)	10	10	¥2,910	
			L-8 (810×390)	10	10	¥3,140	
			L-9 (900×510)	10	10	¥3,700	
	YS220M	40Wステンレスブラケット 両穴釘穴付	L-1 (150×120)	10	10	¥2,170	
			L-2 (210×150)	10	10	¥2,590	
			L-3 (300×210)	10	10	¥3,860	
			L-4 (390×240)	10	10	¥4,620	
			L-5 (510×300)	10	10	¥5,890	
			L-6 (600×300)	10	10	¥6,790	
			L-7 (690×390)	10	10	¥8,260	
			L-8 (810×390)	10	10	¥9,320	
			L-9 (900×510)	10	10	¥10,930	
	Y220D	40Wドブメッキブラケット 両穴釘穴付	L-1 (150×120)	10	10	¥1,200	
			L-2 (210×150)	10	10	¥1,470	
			L-3 (300×210)	10	10	¥1,880	
			L-4 (390×240)	10	10	¥2,370	
			L-5 (510×300)	10	10	¥2,920	
			L-6 (600×300)	10	10	¥3,120	

■50Sブラケット

	品番	品名	サイズ	ケース入数	販売単位	標準価格	
	Y230	50Sユニクロブラケット 片穴	L-1 (200×150)	10	10	¥1,010	
			L-2 (200×200)	10	10	¥1,090	
			L-3 (300×200)	10	10	¥1,400	
			L-4 (400×300)	10	10	¥2,100	
			L-5 (500×300)	10	10	¥2,360	
			L-6 (600×400)	5	5	¥3,020	
			L-7 (700×400)	5	5	¥3,290	
			L-8 (800×400)	1	1	¥3,850	
			L-9 (900×500)	1	1	¥4,390	
	YS230	50Sステンレスブラケット 片穴	L-1 (200×150)	10	10	¥3,040	
			L-2 (200×200)	10	10	¥3,540	
			L-3 (300×200)	10	10	¥4,560	
			L-4 (400×300)	10	10	¥6,020	
			L-5 (500×300)	10	10	¥7,180	
			L-6 (600×400)	5	5	¥8,640	
			L-7 (700×400)	5	5	¥9,950	
			L-8 (800×400)	1	1	¥11,710	
			L-9 (900×500)	1	1	¥13,480	
	Y230D	50SDブメッキブラケット 片穴	L-1 (200×150)	10	10	¥1,610	
			L-2 (200×200)	10	10	¥1,860	
			L-3 (300×200)	10	10	¥2,360	
			L-4 (400×300)	10	10	¥3,350	
			L-5 (500×300)	10	10	¥3,850	
			L-6 (600×400)	5	5	¥4,760	
			L-7 (700×400)	5	5	¥5,200	
			L-8 (800×400)	1	1	¥5,590	
			L-9 (900×500)	1	1	¥6,110	



■50Wブラケット

	品番	品名	サイズ	ケース入数	販売単位	標準価格	
	Y240	50Wユニクロブラケット 両穴	L-1 (200×150)	10	10	¥1,010	
			L-2 (200×200)	10	10	¥1,090	
			L-3 (300×200)	10	10	¥1,400	
			L-4 (400×300)	10	10	¥2,100	
			L-5 (500×300)	10	10	¥2,360	
			L-6 (600×400)	5	5	¥3,020	
			L-7 (700×400)	5	5	¥3,290	
			L-8 (800×400)	1	1	¥3,850	
			L-9 (900×500)	1	1	¥4,390	
	YS240	50Wステンレスブラケット 両穴	L-1 (200×150)	10	10	¥3,040	
			L-2 (200×200)	10	10	¥3,540	
			L-3 (300×200)	10	10	¥4,560	
			L-4 (400×300)	10	10	¥6,020	
			L-5 (500×300)	10	10	¥7,180	
			L-6 (600×400)	5	5	¥8,640	
			L-7 (700×400)	5	5	¥9,950	
			L-8 (800×400)	1	1	¥11,710	
			L-9 (900×500)	1	1	¥13,480	
	Y240D	50Wドブメッキブラケット 両穴	L-1 (200×150)	10	10	¥1,610	
			L-2 (200×200)	10	10	¥1,860	
			L-3 (300×200)	10	10	¥2,360	
			L-4 (400×300)	10	10	¥3,350	
			L-5 (500×300)	10	10	¥3,850	
			L-6 (600×400)	5	5	¥4,760	
			L-7 (700×400)	5	5	¥5,200	
			L-8 (800×400)	1	1	¥5,590	
			L-9 (900×500)	1	1	¥6,110	

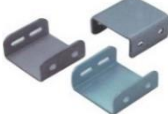
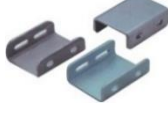
■ベースチャンネル

	品番	品名	サイズ	ケース入数	販売単位	標準価格
	Y270	ベースチャンネルA ユニクロ	A-100×50	40	10	¥710
			A-140×50	30	10	¥1,020
			A-200×50	20	10	¥1,500
			A-270×50	20	10	¥2,020
			A-400×50	1	1	¥2,980
			A-600×50	1	1	¥4,440
			A-1000×50	1	1	¥7,440
			A-2000×50	1	1	¥15,000
	Y270D	ベースチャンネルA ドブメッキ	A-100×50	40	10	¥1,000
			A-140×50	30	10	¥1,390
			A-200×50	20	10	¥2,040
			A-270×50	20	10	¥2,680
			A-400×50	1	1	¥4,080
			A-600×50	1	1	¥6,060
			A-1000×50	1	1	¥10,190
			A-2000×50	1	1	¥20,250
	YS270	ベースチャンネルA ステンレス	A-100×50	40	10	¥2,030
			A-140×50	30	10	¥2,870
			A-200×50	20	10	¥4,080
			A-270×50	20	10	¥5,510
			A-400×50	1	1	¥8,160
			A-600×50	1	1	¥12,260
			A-1000×50	1	1	¥25,950
			A-2000×50	1	1	¥40,840
	Y271	ベースチャンネルB ユニクロ	B-100×40	40	10	¥610
			B-140×40	30	10	¥820
			B-200×40	20	10	¥1,180
			B-270×40	20	10	¥1,540
			B-400×50	1	1	¥2,640
			B-600×50	1	1	¥3,950
			B-1000×50	1	1	¥6,590
			B-2000×50	1	1	¥13,150
	Y271D	ベースチャンネルB ドブメッキ	B-100×40	40	10	¥830
			B-140×40	30	10	¥1,160
			B-200×40	20	10	¥1,690
			B-270×40	20	10	¥2,240
			B-400×50	1	1	¥3,850
			B-600×50	1	1	¥5,730
			B-1000×50	1	1	¥9,580
			B-2000×50	1	1	¥19,280
	YS271	ベースチャンネルB ステンレス	B-100×40	40	10	¥1,550
			B-140×40	30	10	¥2,190
			B-200×40	20	10	¥3,100
			B-270×40	20	10	¥4,170
			B-400×50	1	1	¥7,110
			B-600×50	1	1	¥10,650
			B-1000×50	1	1	¥17,710
			B-2000×50	1	1	¥35,300

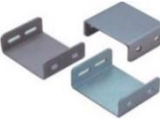
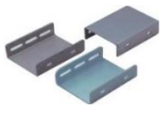
■ベースチャンネル

	品番	品名	サイズ	ケース入数	販売単位	標準価格	
	Y272	ベースチャンネルC ユニクロ	C-100×50	1	1	¥860	
			C-140×50	1	1	¥1,220	
			C-200×50	1	1	¥2,090	
			C-270×50	1	1	¥2,300	
			C-400×65	1	1	¥4,040	
			C-600×65	1	1	¥6,120	
			C-1000×65	1	1	¥10,010	
			C-2000×65	1	1	¥19,800	
	Y272D	ベースチャンネルC ドブメッキ	C-100×50	1	1	¥1,310	
			C-140×50	1	1	¥1,780	
			C-200×50	1	1	¥2,660	
			C-270×50	1	1	¥3,510	
			C-400×65	1	1	¥6,040	
			C-600×65	1	1	¥9,150	
			C-1000×65	1	1	¥14,880	
			C-2000×65	1	1	¥29,380	
	YS272	ベースチャンネルC ステンレス	C-100×50	1	1	¥2,330	
			C-140×50	1	1	¥3,330	
			C-200×50	1	1	¥4,660	
			C-270×50	1	1	¥6,520	
			C-400×65	1	1	¥10,910	
			C-600×65	1	1	¥16,560	
			C-1000×65	1	1	¥27,600	
			C-2000×65	1	1	¥55,100	
	Y273	ベースチャンネルD ユニクロ	D-200×65	1	1	¥2,180	
			D-270×65	1	1	¥2,980	
			D-400×65	1	1	¥4,320	
			D-600×65	1	1	¥6,520	
			D-1000×65	1	1	¥11,020	
			D-2000×65	1	1	¥21,910	
	Y273D	ベースチャンネルD ドブメッキ	D-200×65	1	1	¥3,300	
			D-270×65	1	1	¥4,480	
			D-400×65	1	1	¥6,590	
			D-600×65	1	1	¥9,810	
			D-1000×65	1	1	¥16,580	
			D-2000×65	1	1	¥33,400	
	YS273	ベースチャンネルD ステンレス	D-200×65	1	1	¥5,900	
			D-270×65	1	1	¥8,060	
			D-400×65	1	1	¥12,240	
			D-600×65	1	1	¥18,440	
			D-1000×65	1	1	¥30,500	
			D-2000×65	1	1	¥61,010	
	Y274	ベースチャンネルE ユニクロ	E-200×65	1	1	¥4,640	
			E-270×65	1	1	¥6,360	
		Y274D	ベースチャンネルE ドブメッキ	E-200×65	1	1	¥5,740
				E-270×65	1	1	¥7,660
		YS274	ベースチャンネルE ステンレス	E-200×65	1	1	¥10,100
				E-270×65	1	1	¥10,750
	Y275	30型 ベースチャンネル クロメイト	30×40×1800	1	1	¥5,560	
	Y275D	30型 ベースチャンネル ドブメッキ	30×40×1800	1	1	¥7,230	
	YS275	30型 ベースチャンネル ステンレス	30×40×1800	1	1	¥17,250	
	Y276	50型 ベースチャンネル ユニクロ	50×50×1800	1	1	¥11,900	
	Y276D	50型 ベースチャンネル ドブメッキ	50×50×1800	1	1	¥15,000	
	YS276	50型 ベースチャンネル ステンレス	50×50×1800	1	1	¥35,500	

■アングル接続金具

	品番	品名	サイズ	ケース入数	販売単位	標準価格	
	Y600	No.1 コーナー	ユニクロ	100×100	50	10	¥1,070
	Y600D		ドブメッキ	100×100	50	10	¥1,250
	YS600		ステンレス	100×100	50	10	¥2,960
	Y610	No.2 コーナー通し	ユニクロ	100×100	50	10	¥1,220
	Y610D		ドブメッキ	100×100	50	10	¥1,400
	YS610		ステンレス	100×100	50	10	¥3,170
	Y620L	No.3 ストッパー左	ユニクロ	125×80H	50	10	¥1,080
	Y620LD		ドブメッキ	125×80H	50	10	¥1,160
	YS620L		ステンレス	125×80H	50	10	¥2,560
	Y620R	No.3 ストッパー右	ユニクロ	125×80H	50	10	¥1,080
	Y620RD		ドブメッキ	125×80H	50	10	¥1,160
	YS620R		ステンレス	125×80H	50	10	¥2,560
	Y630	No.4 三角通しコーナー	ユニクロ	100×123	25	1	¥2,420
	Y630D		ドブメッキ	100×123	25	1	¥2,560
	YS630		ステンレス	100×123	25	1	¥4,550
	Y640	No.5 四角通しコーナー	ユニクロ	100×197	15	1	¥3,310
	Y640D		ドブメッキ	100×197	15	1	¥3,590
	YS640		ステンレス	100×197	15	1	¥6,290
	Y650	No.6 台座	ユニクロ	55×79H	50	10	¥1,380
	Y650D		ドブメッキ	55×79H	50	10	¥1,460
	YS650		ステンレス	55×79H	50	10	¥2,620
	Y660	No.7 連結金具	ユニクロ	36×124	50	10	¥730
	Y660D		ドブメッキ	36×124	50	10	¥850
	YS660		ステンレス	36×124	50	10	¥2,230
	Y670	No.8 連結金具	ユニクロ	36×180	50	10	¥830
	Y670D		ドブメッキ	36×180	50	10	¥1,060
	YS670		ステンレス	36×180	50	10	¥2,450

■門型ブラケット スーパーブラケット



	品番	品名	サイズ	ケース入数	販売単位	標準価格
	Y226D	40型 門型ブラケット ドブ	300×250	1	1	¥2,380
			500×250	1	1	¥3,500
			800×250	1	1	¥5,230
	YS226	40型 門型ブラケット ステンレス	300×250	1	1	¥5,450
			500×250	1	1	¥7,980
			800×250	1	1	¥11,810
	Y236D	50型 門型ブラケット ドブ	300×250	1	1	¥4,140
			300×350	1	1	¥4,610
			300×500	1	1	¥5,290
			500×250	1	1	¥6,300
			500×350	1	1	¥6,630
			500×500	1	1	¥7,180
			800×250	1	1	¥8,830
			800×350	1	1	¥9,290
			800×500	1	1	¥9,860
	YS236	50型 門型ブラケット ステンレス	300×250	1	1	¥8,560
			300×350	1	1	¥9,520
			300×500	1	1	¥11,050
			500×250	1	1	¥12,560
			500×350	1	1	¥13,580
			500×500	1	1	¥15,100
			800×250	1	1	¥18,660
			800×350	1	1	¥19,620
			800×500	1	1	¥21,160
	Y680D	補強足 ドブ(穴Φ13)	100×100×50	10	10	¥900
	YS680	補強足 ステンレス(穴Φ13)	100×100×50	10	10	¥1,650
	Y300	スーパーブラケット(ユニクロ)	120型	10	10	¥1,070
			150型	10	10	¥1,400
			200型	10	10	¥2,040
			250型	10	10	¥3,110
			300型	10	10	¥3,860
			400型	10	10	¥8,940
			500型	10	10	¥15,600
	Y300D	スーパーブラケット(ドブメッキ)	120型	10	10	¥1,280
			150型	10	10	¥1,680
			200型	10	10	¥2,430
			250型	10	10	¥3,730
			300型	10	10	¥4,600
			400型	10	10	¥10,660
			500型	10	10	¥18,500
	YS300	スーパーブラケット(SUS)	150型	10	10	¥3,740
			200型	10	10	¥6,050
			250型	10	10	¥8,540
			300型	10	10	¥12,120
			400型	10	10	¥23,120
			500型	10	10	¥42,930

■ツバ付足



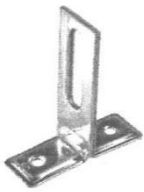

	品番	品名	サイズ	ケース入数	販売単位	標準価格	
	YS684	SUS ツバ付足 25巾	50	180	10	¥890	
			60	180	10	¥980	
			80	130	10	¥1,070	
			100	100	10	¥1,120	
			120	80	10	¥1,220	
			150	70	10	¥1,380	
			200	60	10	¥1,620	
			250	-	-	*受注生産	
			300	-	-	*受注生産	
		SUS ツバ付足 32巾	50	120	10	¥1,090	
			60	120	10	¥1,120	
			80	100	10	¥1,180	
			100	80	10	¥1,220	
			120	70	10	¥1,300	
			150	60	10	¥1,450	
			200	50	10	¥1,850	
			250	-	-	*受注生産	
			300	-	-	*受注生産	







■T字足

	品番	品名	サイズ	ケース入数	販売単位	標準価格
	Y685	ユニクロ プレス一つ穴T字足 25巾	30	300	10	¥90
			40	300	10	¥100
			50	300	10	¥100
			60	250	10	¥110
			80	200	10	¥130
			100	200	10	¥140
			120	150	10	¥150
			150	100	10	¥190
		ユニクロ プレス一つ穴T字足 32巾	60	150	10	¥160
			80	120	10	¥180
100	120		10	¥190		
	YS685	SUS プレス一つ穴T字足 25巾	30	300	10	¥310
			40	300	10	¥340
			50	300	10	¥360
			60	250	10	¥410
			80	200	10	¥430
			100	200	10	¥460
			120	150	10	¥500
			150	100	10	¥580
		SUS プレス一つ穴T字足 32巾	60	150	10	¥460
			80	120	10	¥500
100	120		10	¥550		
	YS688	SUS 溶接一つ穴T字足 25巾	30	100	10	¥900
			40	100	10	¥910
			50	100	10	¥930
			60	100	10	¥940
			80	100	10	¥990
			100	100	10	¥1,040
			120	100	10	¥1,130
			150	80	10	¥1,440
			200	50	10	¥1,690
			250	-	-	*受注生産
		300	-	-	*受注生産	
		SUS 溶接一つ穴T字足 32巾	60	100	10	¥950
			80	100	10	¥1,000
			100	100	10	¥1,050
			120	100	10	¥1,150
			150	80	10	¥1,450
			200	50	10	¥1,700
			250	-	-	*受注生産
300	-		-	*受注生産		

■ボルトナット

	品番	品名	サイズ	ケース入数	販売単位	標準価格
	Y759	ユニクロボルト	3/8×20	160	160	¥26
			3/8×25	150	150	¥29
			3/8×32	150	150	¥34
			3/8×38	100	100	¥36
			3/8×45	90	90	¥41
			3/8×50	80	80	¥43
	YS759	ステンレスボルト	3/8×16	80	80	¥55
			3/8×20	80	80	¥59
			3/8×25	80	80	¥70
			3/8×30	80	80	¥73
			3/8×35	60	60	¥78
			3/8×40	60	60	¥140
			3/8×45	60	60	¥143
			3/8×50	60	60	¥146
	Y712	六角ナット(ユニクロ)	3/8	3000	300	¥17
	Y722		1/2	1500	150	¥31
	YS742	六角ナット(ステンレス)	3/8	3000	300	¥36
	YS752		1/2	1500	150	¥68
	Y713	丸座金(ユニクロ)	3/8	5000	500	¥14
	Y723		1/2	5000	500	¥22
	YS743	丸座金(ステンレス)	3/8	5000	500	¥23
	YS753		1/2	5000	500	¥31
	Y760	ユニクロボルト(半ネジ)	M12×40	600	600	¥71
			M12×45	600	600	¥72
			M12×50	600	600	¥78
			M12×55	500	500	¥80
			M12×60	500	500	¥84
			M12×65	400	400	¥92
			M12×70	400	400	¥96
			M12×75	400	400	¥108
			M12×80	350	350	¥110
			M12×85	330	330	¥118
			M12×90	330	330	¥132
			M12×100	300	300	¥139
			M16×45	320	320	¥126
			M16×50	290	290	¥130
			M16×55	270	270	¥132
			M16×60	260	260	¥134
			M16×65	240	240	¥139
			M16×70	220	220	¥162
			M16×75	210	210	¥164
			M16×80	190	190	¥180
			M16×85	180	180	¥191
			M16×90	170	170	¥209
			M16×100	120	120	¥234
			M16×110	100	10	¥271
			M16×120	100	10	¥316
			M16×130	100	10	¥354
			M16×140	100	10	¥366
			M16×150	100	10	¥392
M16×160	100	10	¥427			
M16×170	100	10	¥480			
M16×180	100	10	¥580			
	Y761	ユニクロボルト(全ネジ)	M12×40	600	600	¥70
			M12×45	600	600	¥71
			M12×50	600	600	¥76
			M12×55	500	500	¥78
			M12×60	500	500	¥82
			M12×65	400	400	¥90
			M12×70	400	400	¥94
			M12×75	400	400	¥106
			M12×80	350	350	¥108
			M12×85	330	330	¥115
			M12×90	330	330	¥130
			M12×100	300	300	¥132
			M16×40	350	350	¥120
			M16×45	320	320	¥124
			M16×50	290	290	¥127
			M16×55	270	270	¥130
			M16×60	260	260	¥132
			M16×65	240	240	¥137
			M16×70	220	220	¥156
			M16×75	210	210	¥161
			M16×80	190	190	¥175
			M16×85	180	180	¥187
			M16×90	170	170	¥204
			M16×100	150	150	¥229



■ボルトナット

	品番	品名	サイズ	ケース入数	販売単位	標準価格
	YS760	ステンレスボルト(半ネジ)	M12×40	400	400	¥148
			M12×45	400	400	¥151
			M12×50	300	300	¥156
			M12×55	300	300	¥163
			M12×60	300	300	¥185
			M12×65	300	300	¥200
			M12×70	240	240	¥212
			M12×75	240	240	¥229
			M12×80	240	240	¥231
			M12×85	240	240	¥255
			M12×90	240	240	¥260
			M12×100	210	210	¥278
			M16×50	240	40	¥289
			M16×55	210	35	¥315
			M16×60	210	35	¥341
			M16×65	180	30	¥359
			M16×70	180	30	¥378
			M16×75	180	30	¥385
			M16×80	150	25	¥419
			M16×85	150	25	¥446
			M16×90	120	20	¥459
			M16×100	120	20	¥515
			M16×110	100	10	¥608
M16×120	100	10	¥657			
M16×130	100	10	¥705			
M16×140	100	10	¥787			
M16×150	100	10	¥852			
M16×160	100	10	¥1,083			
M16×170	100	10	¥1,156			
M16×180	100	10	¥1,552			
	YS761	ステンレスボルト(全ネジ)	M12×40	400	400	¥146
			M12×45	400	400	¥148
			M12×50	300	300	¥153
			M12×55	300	300	¥160
			M12×60	300	300	¥182
			M12×65	300	300	¥195
			M12×70	240	240	¥205
			M12×75	240	240	¥221
			M12×80	240	240	¥224
			M12×85	240	240	¥247
			M12×90	240	240	¥251
			M12×100	210	210	¥269
			M16×40	300	50	¥273
			M16×45	240	40	¥281
			M16×50	240	40	¥283
			M16×55	210	35	¥308
			M16×60	210	35	¥334
			M16×65	180	30	¥351
			M16×70	180	30	¥371
			M16×75	180	30	¥377
			M16×80	150	25	¥411
			M16×85	150	25	¥438
			M16×90	120	20	¥451
M16×100	120	20	¥507			
	Y771	六角ナット(ユニクロ)	M12	2000	200	¥23
	YS771	六角ナット(ステンレス)	M16	1000	100	¥38
	Y776	平座金(ユニクロ)	M12	5000	500	¥18
	YS776	平座金(ステンレス)	M16	5000	300	¥25
			M12	5000	500	¥33
			M16	3000	300	¥43

■寸切り

	Y710	長ねじ(寸切り) ユニクロ	3/8×1000	50	50	¥240
	Y711		3/8×2000	25	25	¥460
	Y720		1/2×1000	25	25	¥600
	Y721		1/2×2000	15	15	¥1,160
	YS740	長ねじ(寸切り) ステンレス	3/8×1000	50	50	¥900
	YS741		3/8×2000	25	25	¥1,690
	YS750		1/2×1000	25	25	¥1,680
	YS751		1/2×2000	15	15	¥3,200

■ 芯棒打込式アンカー

	品番	品名	サイズ	ケース入数	販売単位	標準価格
	Y755	打込式アンカー Cタイプ (電解亜鉛メッキ)	C645	50	50	¥76
			C660	50	50	¥90
			C840	50	50	¥79
			C850	50	50	¥93
			C860	50	50	¥99
			C870	50	50	¥104
			C880	50	50	¥125
			C890	50	50	¥169
			C1050	50	50	¥105
			C1060	50	50	¥116
			C1070	50	50	¥143
			C1080	50	50	¥165
			C1090	50	50	¥171
			C1260	30	30	¥158
			C1270	30	30	¥170
			C1280	30	30	¥210
			C1290	30	30	¥236
	YS755	打込式アンカー SCタイプ (ステンレス)	SC625	100	100	¥175
			SC645	50	50	¥238
			SC660	50	50	¥300
			SC850	50	50	¥250
			SC860	50	50	¥300
			SC870	50	50	¥338
			SC880	50	50	¥413
			SC890	50	50	¥450
			SC1050	50	50	¥375
			SC1060	50	50	¥425
			SC1070	50	50	¥450
			SC1080	50	50	¥575
			SC1090	50	50	¥625
			SC1260	30	30	¥588
			SC1270	30	30	¥638
			SC1280	30	30	¥700
			SC1290	30	30	¥875

## ■ウェッジ式アンカー

	品番	品名	サイズ	ケース入数	販売単位	標準価格
	Y756	ウェッジ式アンカー HWタイプ (電解亜鉛メッキ)	HW857	50	50	¥75
			HW1068	30	30	¥117
			HW10100	30	30	¥124
			HW1280	25	25	¥137
			HW12100	25	25	¥144
			HW12120	25	25	¥178
	YS756	ウェッジ式アンカー SHWタイプ (ステンレス)	SHW857	50	50	¥311
			SHW1068	30	30	¥459
			SHW10100	30	30	¥527
			SHW1280	25	25	¥797
			SHW12100	25	25	¥851

### ■構造

ナットを締め付けることにより、ウェッジ部をアンカー先端の形状に沿って拡張させ、施工面の孔壁に固着する製品です。

### ■特長

- ①規定トルク値までナットを締め付けることで施工が完了するので、施工者が固着を確認することができます。
- ②追従拡張型でもっとも安全な構造です。  
外的要因（振動、コンクリート劣化）などにより、アンカーが抜けようとする力が作用した場合、拡張部（ウェッジ）が追従して拡張する安全な構造です。
- ③他の追従拡張型アンカーと異なり、ネジ径と同じ外径及び穿孔径である為、取付物の上から施工できます。
- ④トルク式のため打撃式では施工が難しい隅打ちが可能です。
- ⑤模様替え等によるアンカー不要時には、コンクリート内への埋込み対応が可能です。

### ■用途

椅子取付け、配管・ダクト取付け、機械設置、エレベーター設置工事など。

### ■施工方法

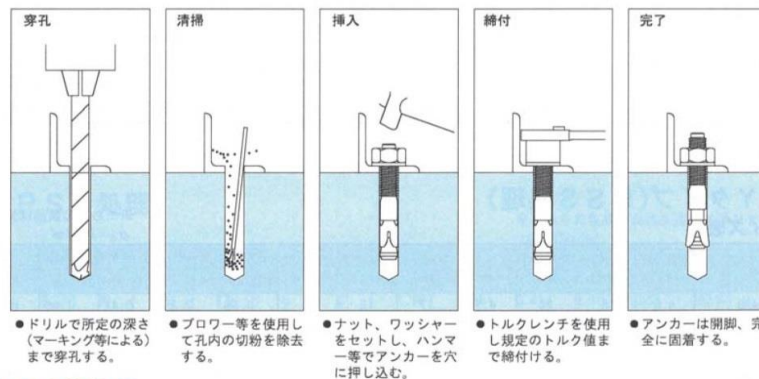

### ■施工に関する注意事項

施工にはトルクレンチを使用し、所定のトルクまで締め付けて下さい。

#### ①ナットセット時

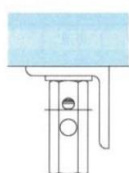

施工にあたり高ナット、ワッシャーをアンカーにセットする際、アンカーで高ナットの小さな穴が塞がるまで（図の細線まで）ねじ込んで下さい。

#### ②ナット締付時

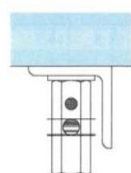

トルクレンチ等で規定のトルク値まで締付け後、アンカーの先端が大きい穴の範囲内（図の太線から二重線の間）にあれば施工完了です。大きい穴を塞いでも（図の二重線の位置に達しても）規定トルク値に達しない場合、施工不良の恐れがあります。別の場所で、再施工してください。

#### 高ナットタイプ（上向き施工）の場合

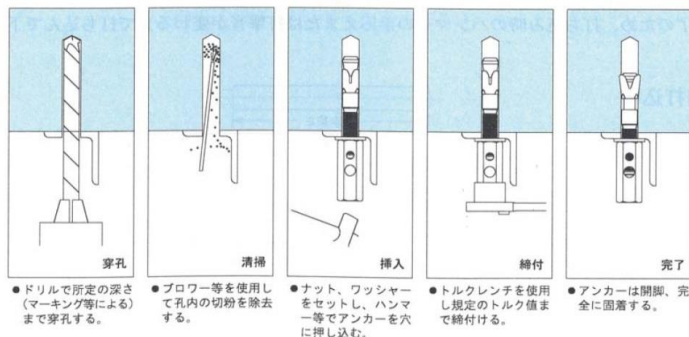

■ステンレス製 散水栓ボックス

	品番	品名	サイズ	ケース入数	販売単位	標準価格	
	M860	住宅用散水栓ボックス(床用)	250×175×95	12	1	¥14,500	
	M860B	散水栓ボックス(床用底板付)	250×175×95	12	1	¥18,700	
	M861	散水栓ボックス(床用)	250×175×130	12	1	¥43,000	
	M861B	散水栓ボックス(床用底板付)	250×175×130	12	1	¥49,000	
	M861D	散水栓ボックス(床用D式カギ型)	250×175×130	12	1	¥49,800	
	M862	散水栓ボックス(床用)	280×205×150	12	1	¥53,400	
	M862B	散水栓ボックス(床用底板付)	280×205×150	12	1	¥59,000	
※D式カギ	M862D	散水栓ボックス(床用D式カギ型)	280×205×150	12	1	¥61,000	
	M865B	散水栓ボックス(床用底板付)	250×175×130	12	1	¥39,300	
	M866	散水栓ボックス(床用)	320×230×150	12	1	¥66,000	
	M866B	散水栓ボックス(床用底板付)	320×230×150	12	1	¥71,000	
	M866D	散水栓ボックス(床用D式カギ型)	320×230×150	12	1	¥74,000	
	M868	散水栓ボックス(床用)	235×190×95	12	12	¥12,100	
	M863	散水栓ボックス (床板・配管ユニット付)  * 20ページをご参照ください。	286×202×190	8	8	¥4,200	

■ステンレス製 散水栓ボックス

	品番	品名	サイズ	ケース入数	販売単位	標準価格	
	M871	散水栓ボックス(壁用)	250×175×130	12	1	¥45,000	
	M871K	散水栓ボックス(壁用調節)	250×175×130	12	1	¥51,500	
	M871R	散水栓ボックス(壁用露出型)	250×175×130	12	1	¥61,200	
	M874	散水栓ボックス(壁用)	250×175×95	12	1	¥26,000	
	M874B	散水栓ボックス(壁用底板付)	250×175×95	12	1	¥32,000	
	M876	散水栓ボックス(壁用)	250×200×150	12	1	¥77,000	
	M876R	散水栓ボックス(壁用露出型)	250×200×150	12	1	¥87,500	
	M877	散水栓ボックス(壁用)	300×250×150	12	1	¥92,000	
	M877R	散水栓ボックス(壁用露出型)	300×250×150	12	1	¥102,000	
	M878	散水栓ボックス(壁用カギ式)	235×190×95	12	1	¥15,500	
	M878A	散水栓ボックス(壁用フッシュ式)	235×190×95	12	1	¥14,600	
	M878T	散水栓ボックス(壁用トツテ式)	235×190×95	12	1	¥14,600	
	M879	散水栓ボックス(壁用カギ式)	235×190×95	12	1	¥15,500	
	M879A	散水栓ボックス(壁用フッシュ式)	235×190×95	12	1	¥14,600	
	M879T	散水栓ボックス(壁用トツテ式)	235×190×95	12	1	¥14,600	



## 株式会社 モリテック

本社 〒581-0811 大阪府八尾市新家町3-6-4-1 TEL 072-928-0188 FAX 072-928-0186  
福岡営業所 〒816-0906 福岡県大野城市1丁目5-27(マイスピア)B-1 TEL 092-580-8803 FAX 092-580-8804

ホームページ <http://www.moritec.co.jp>



## 株式会社 モリテックイースト

〒124-0022 東京都葛飾区奥戸2丁目31番16号 TEL 03-6662-8308 FAX 03-6662-8309

RBcbc